



FIRE - RATED  
HOLLOW METAL  
DOORS AND FRAMES

THIRD EDITION





#### DISCLAIMER

This Manual was developed by representative members of and approved by the Hollow Metal Manufacturers Association (HMMA) Division of the National Association of Architectural Metal Manufacturers (NAAMM) to provide their opinion and guidance on the specification and use of fire-rated hollow metal doors and frames. This Manual contains advisory information only and is published as a public service by NAAMM. NAAMM disclaims all liability of any kind for the use, application or adaptation of material published in this Manual.

*Purchasers of NAAMM Standards may receive current information on all NAAMM Standards by calling or writing The National Association of Architectural Metal Manufacturers.*

**National Association of Architectural Metal Manufacturers**

8 South Michigan Avenue • Chicago, Illinois 60603 • 1-312-332-0405

Fax 1-312-332-0706 • Website: [www.naamm.org](http://www.naamm.org)

Copyright (c) 1974, 1983, 2000

National Association of Architectural Metal Manufacturers

All Rights Reserved

# CONTENTS

---

**GENERAL INFORMATION** ..... **Section 1**

- Protection of Wall Openings
- Basic Requirements
- Classification of Fire Doors
- Fire Tests
- Listing, Labeling and Certification Organizations
- Design Limitations
- Local Regulations; The Architect's Responsibilities
- Guidelines for Proper Usage
- Ranges of Types and Sizes Available
- Labels for Hollow Metal Fire Doors and Frames
- Representative Types of Hollow Metal Fire Doors
- Labeled Glazing Materials for Hollow Metal Fire Doors
- Representative Types of Fire Door Frames
- Labeled Materials for Transom, Sidelight and Window Assemblies
- References

**HARDWARE FOR SWINGING FIRE DOORS** ..... **Section 2**

- General Hardware Requirements
- Builders Hardware for Singles and Pairs of Doors
- Builders Hardware for Pairs of Doors
- Hardware Code Summary

**FIRE - RATED DOORS AND FRAMES** ..... **Section 3**

- Basic Hollow Metal Fire Doors
- Pairs of Hollow Metal Fire Doors in a Means of Egress
- Temperature Rise Rated Hollow Metal Fire Doors
- Double Egress Hollow Metal Fire Doors and Frames
- Stainless Steel Fire Doors
- Dutch Hollow Metal Fire Doors
- Louvered Hollow Metal Fire Doors
- Three-Sided Door Frames
- Multiple Opening Frames and Transom Frames
- Frames with 1-3/4" (44 mm) Transom Panels Without Transom Mullion
- Transom Frames - with 1-3/4" (44 mm) Transom Panels and Transom Mullion
- Transom Frames - Glazed Transom Frames with Transom Panels and Transom Mullions
- Sidelight Frames - Glazed or Paneled
- Window Frames - Glazed or Paneled
- Special Purpose Fire Door and Frame Assemblies
- Profiles for Fire-Rated Frame Product
- Anchors for Fire-Rated Frame Product
- Summary - Hollow Metal Fire Doors
- Summary - Fire Door Frame Product

## **FORWORD**

---

NAAMM published the first edition of this manual in 1974. This first edition was entitled "Fire-Rated Custom Metal Doors and Frames". Much progress has been made in the development of door and frame assemblies capable of providing fire protection in wall openings since the publication of the first edition. The second edition was published in 1983.

It is the purpose of this third edition to present data on current practices within the industry with emphasis on the requirements of the National Fire Protection Association (NFPA) and Model Codes within the United States. Fire testing, listing, labeling and certification services are thoroughly covered. The section on hardware and its proper use with fire-rated doors has been considerably expanded. The section on fire-rated products describes classified doors and frames currently available from NAAMM/HMMA member companies. It is believed that this third edition will prove to be a valuable reference manual to those responsible for specifying fire protection products. NAAMM will welcome any comments regarding the content of the manual and will appreciate suggestions for improvement of future editions.

**GENERAL INFORMATION**

**CONTENTS**

---

Protection of Wall Openings . . . . . 1-2

Basic Requirements . . . . . 1-2

Classification of Fire Doors . . . . . 1-3

Fire Tests . . . . . 1-3

Listing, Labeling and  
Certification Organizations . . . . . 1-5

Design Limitations. . . . . 1-6

Local Regulations; The Architect's  
Responsibilities . . . . . 1-7

Guidelines for Proper Usage . . . . . 1-7

Range of Types and Sizes Available . . . . . 1-7

Labels for Hollow Metal Fire  
Doors and Frames . . . . . 1-8

Representative Types of Hollow  
Metal Fire Doors . . . . . 1-9

Labeled Glazing Materials for  
Hollow Metal Fire Doors . . . . . 1-9

Representative Types of Fire Door Frames . . . . . 1-10

Labeled Materials for Transom, Sidelight  
and Window Assemblies . . . . . 1-10

References . . . . . 1-11

## Protection of Wall Openings

Hollow metal door and frame assemblies play a crucial role in providing the fire and life safety protection required in any building. There are however a number of variations in the designs and performance levels of these products. Therefore, in order to make the proper selection, it is essential that specifiers have adequate information on the different fire door and frame assemblies available.

Fire protection requirements are established by the building code governing the area in which the building is to be erected. These requirements will depend on the uses or occupancy groups within the building (i.e., the specific locations in the building and the potential fire hazards of particular areas). Hollow metal fire door assemblies achieve ratings ranging from 1/3 hour to a maximum of 3 hours which are determined by the exposure limitations of the assembly itself.

This manual provides information needed to select and specify swinging fire door assemblies to provide the level of fire resistance required.

As used in this document, the term “fire doors” refers to swinging hollow metal door and frame product designed to limit the passage of flame through the wall openings they protect.

Section 3 describes swinging hollow metal fire doors and frames and the following special purpose hollow metal fire door assemblies:

- Sound Control Assemblies
- Detention Security Assemblies
- Bullet Resistant Assemblies
- Radiation Shielding Door Assemblies

Since manufacturers of hollow metal doors and frames are continually improving existing products and introducing new ones, it is recommended that manufacturers be contacted regarding current fire rating capabilities if the design criteria desired is beyond the scope of the products described in this manual. Contact the NAAMM office at (312) 332-0405, e-mail at [naamm@gss.net](mailto:naamm@gss.net) or the web site at [www.naamm.org](http://www.naamm.org) for information on currently available fire-rated doors and frames.

## Basic Requirements

Fire protection of a wall opening requires a complete “fire door assembly”. The architect must be certain that the entire assembly, which includes the door, frame, glazing, hardware and installation have been proven to be capable of providing the level of protection required by the governing code and is properly labeled. Fire door assemblies submitted for testing consist of a spe-

cific type of door and/or frame construction and specific types of hardware. It is this particular combination of elements that is evaluated. Most typical combinations of these labeled elements are presented in this manual.

The basic requirements and limitations affecting the installation and maintenance of fire door assemblies are defined in the National Fire Protection Association “Standard for Fire Doors and Fire Windows”, ANSI/NFPA 80. The most common fire protection ratings required by North American codes are 3, 1-1/2, 1, 3/4 and 1/3 hour, which indicate the duration of test exposure the elements have endured. Labels, Certification or Listing Marks provide evidence that each specific element has been listed by a nationally recognized certification organization having a factory inspection service and has been constructed as detailed in the Follow-Up Service Procedures/Factory Inspection Manuals issued by the certification organization.

A temperature rise rating (TRR) shown on a fire door label is in addition to the fire protection rating. It indicates a maximum temperature rise, above ambient, developed on the unexposed face of the door at the 30 minute point of a Standard Fire Test. Such labels indicate that the rise in temperature does not exceed 250°F (121°C), 450°F (232°C) or 650°F (343°C).

Temperature rise ratings are not available for doors with 1/4 inch (6 millimeter) listed wired glass areas exceeding 100 square inches (0.065 square meters) or for doors provided with louvers. There are however labeled specialty glazing materials available capable of resisting the passage of heat which are permitted to exceed the 100 square inch restriction.

Labels on doors cover only the design and construction of the doors. A separate label on the frame certifies its design and construction.

Typical labels are shown on page 1-8 in the section on Listing, Labeling and Certification Organizations.

Table 1 lists some of the requirements of ANSI/NFPA 80 and ANSI/NFPA 101. In addition to the data tabulated, there are other important requirements which apply to all fire doors. Among these are the following:

1. Each frame assembly and each door leaf must be labeled.
2. Each fire door must be self-closing or close automatically in the event of a fire, unless exempted by code. They must also be self-latching and remain closed at the time of fire in order to provide a dependable barrier against fire.
3. Automatically closing doors may be held open by

a separate, labeled, fail-safe door holder/release device or a hold-open mechanism which is an integral part of the basic closing device, provided the hold-open mechanism is released by one or a combination of automatic fire detectors acceptable to the Authority Having Jurisdiction.

4. Power operated fire doors shall be equipped with a detection device which will automatically cut the power to the operator. The operator will then cause the door to close and latch.

5. Fire doors serving in a “required means of egress” from places of assembly having an occupancy load of 100 persons or more must be equipped with fire exit hardware. Such hardware is listed both for fire and panic protection. The label is intended to differentiate between fire exit hardware and panic exit hardware. Only fire exit hardware is permitted to be used on fire doors.

**Classification of Fire Doors**

Fire doors are classified by hourly ratings. The hourly rating indicates the duration of the fire test exposure and is called the “fire protection rating”.

Table 1 provides the relationship between the door location, wall rating and the required hourly rating for the opening protected (door and frame).

Opening	Wall Rating	Door/Frame Rating
Openings in walls which separate buildings or divide a single building into fire areas	4 hour	3 hour
Openings in; enclosures of vertical communication such as stairwells or elevator shafts or; in exterior walls subject to severe fire exposure from outside the building	2 hour	1½ hour
Openings in walls between occupancies	1 hour	1 hour
Openings in; corridors and room partitions or; in exterior walls subject to moderate to light fire exposure from outside the building	1 hour	¾ hour
Openings where smoke control is a primary consideration for partitions between a habitable room and a corridor when the wall is constructed to have a fire resistance of more than 1 hour or across corridors where a smoke partition is required	1 hour	1/3 hour (no hose stream)

Note : The local Authority Having Jurisdiction and Building Code specify the hourly rating for any location

TABLE 1

Refer to Tables 4 and 5 on Pages 1-9 and 1-10 for limitations on glazing materials permitted in door and frame product.

The local building code specifies the hourly rating for any location. Generally, fire doors and frames that qualify for a specific rating also qualify for all lower ratings.

**Fire Tests**

The hourly fire ratings for fire door assemblies (doors, frames and hardware) are determined by the length of time the assemblies satisfactorily withstand a standard fire test. Model and Building Codes, which specify the Standards used to test and evaluate fire door assemblies, are undergoing significant changes.

Fire door assemblies, since the early 1900’s, have been tested to what have evolved into the ANSI/UL10b and ANSI/NFPA 252 Standards. These describe both the test method and pass/fail criteria. The neutral pressure plane for these Standards has historically been located at the top of the fire door assembly.

In 1997 the International Conference of Building Officials (ICBO) adopted and published a positive pressure test method for side-hinged doors, UBC 7-2 (1997) for the Uniform Building Code (UBC). UL has developed ANSI/UL10c which addresses all the requirements of the UBC standard. ANSI/UL10c and UBC 7-2 (1997) require the neutral pressure plane to be located 40 inches (1016 millimeters) from the bottom of the fire door assembly.

Other changes, such as the development of positive pressure fire test standards by NFPA, ASTM and the International Building Code (IBC), a single Model Code for the United States are evolving.

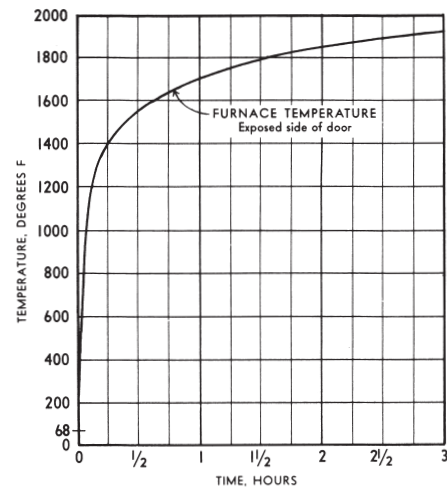

FIGURE 1

STANDARD TIME-TEMPERATURE CURVE



The test, which is generally the same in all these Standards, consists of building the door assembly, complete with hardware, into a masonry, steel or wood stud wall. The door assembly and wall are located on the face of a gas-fired furnace. Furnace temperature is controlled in accordance with the standard time-temperature curve shown in Figure 1 (page 1-3) and the neutral pressure plane is located as per the specific Standard requirements.

The points on the curve that determine its character are shown in Table 2. The exposure time is determined by the hourly rating required for the door assembly.

Temperature		Time
Degrees F	Degrees C	Hours:Minutes
1000	538	0:05
1300	704	0:10
1462	795	0:20
1550	843	0:30
1638	892	0:45
1700	927	1:00
1792	978	1:30
1850	1010	2:00
1925	1052	3:00
2000	1093	4:00

TABLE 2

For temperature rise rated doors under ANSI/UL10c and UBC 7-2 (1997), a cotton pad is held at the cracks, seams or openings where hot gases may escape during the first 30 minutes of the test.

Immediately following the required period of fire exposure the assembly is removed from the furnace and subjected to the impact, erosion and cooling effects of a stream of water of specified nozzle pressure from a 2-1/2 inch (63 millimeters) hose with a 1-1/8 inch (28 millimeters) nozzle, commonly known as the "hose stream test". The water pressure and duration of application for different ratings are shown in Table 3. Fire tests of 1/3 hour duration may be conducted without the hose stream.

Fire window frames and glazing materials are tested in accordance with Underwriters' Laboratories ANSI/UL9 or ANSI/NFPA 257 for negative pressure requirements. UBC 7-4 (1997) is the positive pressure equivalent, with a UL standard being proposed. The furnace time-temperature curve and hose stream procedures are the same as those of ANSI/UL10b and ANSI/NFPA 252. However, the length of fire exposure is generally

limited to 3/4 hour, except for glass block and special types of glazing designed for longer exposures. Reference should be made to these Standards for other requirements.

Desired Rating	Water Pressure At Base of Nozzle PSI (kPa)	Duration of Application: Seconds/Square Foot (s/m <sup>2</sup> ) of Exposed Area <sup>(1)</sup>
3 hours	45 (310)	3.0 (32)
1-1/2 hour and over if less than 3 hours	30 (207)	1.5 (16)
1 hour and over if less than 1-1/2 hours	30 (207)	0.9 (10)
Less than 1 hour	30 (207)	0.6 (6)

(1) : The exposed area shall be calculated using the outside dimensions of the test specimen, including a frame, hangers, tracks or other parts of the assembly if provided, but normally not including the wall into which the specimen is mounted. Where multiple test specimens are mounted in the same wall, the rectangular or square wall area encompassing all of the specimens will have to be considered as the exposed area since the hose stream must traverse this area during its application.

TABLE 3

WATER PRESSURE AT BASE OF NOZZLE AND DURATION OF APPLICATION

The following are the general conditions of acceptance of performance when subjected to the standard fire tests.

A door assembly shall be considered as meeting the requirements of acceptable performance when it remains in the opening during the fire endurance and hose-stream test (where required) within the following limitations.

1. The test assembly shall withstand the fire endurance test and hose-stream test (where required), without developing openings anywhere through the assembly.
2. Dislodging of small portions of glass, not exceeding 5 percent of the glass light area, by the hose stream is acceptable.
3. Separation between meeting edges of pairs of doors, within the limits specified in 7 and 8 below, are acceptable.
4. Frames shall remain securely fastened to the wall on all sides and shall not permit through openings between frame and adjacent wall or between the frame and doors.

5. The movement of swinging doors shall not result in any portion of the edges adjacent to the door frame moving from their original position, in a direction perpendicular to the plane of the door, more than the thickness of the door during the first half of the classification period, nor more than 1-1/2 times the door thickness during the entire classification period or as a result of the hose stream test. For positive pressure tested assemblies, the movement shall be no more than the door thickness during the entire classification period, nor more than 1-1/2 times the door thickness as a result of the hose stream.

6. The movement of swinging doors mounted in pairs shall not result in any portion of the meeting edges moving more than the thickness of the door away from the adjacent door edge, in a direction perpendicular to the plane of the doors, during the entire classification period or as a result of the hose stream test.

7. An assembly consisting of a pair of swinging doors incorporating an astragal shall not separate in a direction parallel to the plane of the doors more than 3/4 inch (19.1 millimeters) nor a distance equal to the throw of a latch bolt at the latch location.

8. An assembly consisting of a pair of swinging doors, without an overlapping astragal, for a fire and hose stream exposure of 1-1/2 hours or less, shall not separate along the meeting edges more than 3/8 inch (9.5 millimeters) including the initial clearance between doors.

9. An assembly consisting of a single swinging door shall not separate more than 1/2 inch (12.7 millimeters) at the latch location.

10. No flaming shall occur on the unexposed surface of a door assembly during the first 30 minutes of the classification period. For positive pressure temperature rise rated doors sustained flaming of less than 10 seconds duration is permitted. For temperature rise rated doors the assembly shall not permit the passage of hot gases sufficient to ignite the cotton pad during the first 30 minutes of exposure.

11. After 30 minutes, some intermittent light flames (approximately 6 inches (152 millimeters) long), for periods not exceeding 5 minute intervals, may occur along the edges of the doors.

12. Light flaming may occur during the last 15 minutes of the classification period on the unexposed surface area of the door, provided it is contained within a distance of 1-1/2 inches (38.1 millimeters) from a vertical door edge, within 3 inches (76.2 millimeters) from the top edge of the door or within 3 inches (76.2 millimeters) from the top edge of the frame of a vision panel.

A glazing assembly shall be considered as meeting

the requirements for acceptable performance if it remains in the opening during the fire endurance test and hose stream test (where required), within the following limitations:

1. The glazing assembly shall not be loosened from its fastenings.

2. Movement at the perimeter of operable components from the initial closed position shall not exceed the thickness of the frame member at any point.

3. During the fire test exposure, separation of the glass edges from the frame, so as to create an opening, is not permitted.

4. Separation of the glass edges from the glazing frame, by movements away from the frame so as to create an opening during the hose stream test, shall not exceed 30 percent of each individual glass light perimeter.

5. During the hose stream test, openings created by glass breakage in the central area of each glass light shall not exceed 5 percent of the area of each individual glass light.

“Openings” for the purpose of the above three paragraphs are defined as through holes in the assembly than can be seen from the unexposed side when looking perpendicular through the plane of the assembly at the location of the suspected opening.

Any variation from the construction tested may substantially change the performance characteristics of the assembly. Testing laboratories have procedures for evaluating alternative constructions or features. Where evaluations determine that such alternatives do not impact the performance characteristics of the assembly, their use will be permitted.

### **Listing, Labeling and Certification Organizations**

Qualified fire doors, frames and windows shall be identified as such only by the presence of a label issued by a certification organization such as Underwriters Laboratories, Inc. (UL), Intertek Testing Services/Warnock Hersey (ITS/WHI) or Factory Mutual (FM).

Labels appropriate for various conditions and requirements are provided as evidence that these products have passed a standard fire test. Certification organizations have developed independent policies regarding the information which is required on their labels. All fire labels indicate the certification organization name and “mark” (logo), the manufacturer (by name, logo or control number), wording such as “Listed”, “Approved” or “Classified”, a description of the product such as “Swinging Fire Door”, “Fire Door Frame” or “Fire Window Frame” and a serial or control number. All fire

door labels must indicate the maximum fire rating. Fire door frame labels may include the maximum fire rating. Labeled frame products installed in drywall partitions are rated up to 1-1/2 hours unless indicated otherwise on the label. Labeled frame products in all other types of walls are rated to 3 hours unless stated otherwise on the label.

The rating of the installed assembly is equal to that of the door, frame or hardware, whichever is less. If any element of the assembly (door, frame or hardware) is omitted, does not comply with its listed installation requirements or does not bear a label, the entire assembly is considered non-labeled.

For openings where temperature rise ratings are required, the label will include text indicating the maximum TRR, in degrees Fahrenheit, at 30 minutes in addition to the fire endurance rating. For negative pressure tested assemblies, if a temperature rise is not indicated on the label, it exceeds 650 degrees Fahrenheit (340 degrees Celsius). Positive pressure tested door labels, under UBC, are required to indicate either 250°F (121°C), 450°F (232°C), 650°F (343°C) or exceeds 650°F (343°C) temperature rise.

Certification organizations may also require additional information on their specific labels. Examples include differentiating between doors reinforced for fire exit hardware and those for single-point locks/latches. Certification organizations may require a Factory Identification Mark to identify the location of the plant applying the label. The certification organization may also require a description of the product by model name or number.

Labels are available in a number of materials which include adhesive-backed mylar labels or metal labels which can be riveted or welded to the product. Some member manufacturers provide fire labels which are embossed directly into their products. See Page 1-8 for facsimiles of door and frame labels.

Underwriters Laboratories, ITS/Warnock Hersey and Factory Mutual evaluate products on the basis of their performance under the standard fire endurance and hose stream tests already described.

UL, WHI and FM require that their representatives witness the fire test when conducted at facilities other than their own. When inter-laboratory agreements exist, this requirement may be waived.

Fire testing is only the first stage of the listing and certification process. UL, WHI and FM Follow-Up programs verify labeled product conformance by conducting frequent unscheduled inspections for quality control and product fabrication in the manufacturer's plant.

## Design Limitations

It is essential that the architect recognize the design limitations imposed on fire door assemblies which are required to be fire rated and labeled. Some of these limitations have already been mentioned, but there are others, too, which cannot be disregarded.

Hollow metal fire doors and frames must be made of hot rolled, cold rolled, galvanized, galvanized or stainless steel. Frames are available in single or double rabbet profiles. Glazing materials, where permitted, must be labeled for fire resistance.

The selection of hardware is of particular importance. Only hardware which has passed the appropriate fire and hose stream test shall be permitted. The type of hardware specified may limit the assembly size or its fire protection rating.

Closing devices are required on all fire doors and the inactive leaf of all pairs must have automatic or self-latching top and bottom bolts except when used on rooms not normally occupied by humans. Refer to ANSI/NFPA 80 for exceptions.

All single doors and the active leafs of pairs must be provided with locks or latches with an active latch bolt which cannot be held in the retracted position. When single-point latching hardware is used the maximum permissible door size is governed by the length of the latch throw. These limitations may differ from manufacturer to manufacturer, due to differences in construction details.

Panic exit hardware is not permitted on fire doors. To be acceptable for use in fire exits, such devices must also be listed as fire exit hardware.

These regulations are some of the most important with respect to hardware. They indicate the complexity of the rules affecting design features. For a more comprehensive and detailed explanation of hardware requirements see Section 2, "Hardware for Swinging Hollow Metal Fire Doors" and Section 3, "Fire Rated Doors and Frames" in this manual. Also see the handbook entitled "Hardware for Labeled Fire Doors" published by the Door and Hardware Institute. Listings for labeled hardware may be found in the "Building Materials Directory" published by Underwriters' Laboratories, the ITS/Warnock Hersey "Directory of Listed Products" or the Factory Mutual Research "Approval Guide". Requests for information, clarification or advice will be welcomed by any member company of the Hollow Metal Manufacturers Association, a Division of NAAMM.

## **Local Regulations; The Architect's Responsibilities**

It should be emphasized that the foregoing discussion has, of necessity, dealt with generally accepted national regulations, but not all of these standards necessarily apply in all locations. The Authority Having Jurisdiction generally base their requirements on NFPA Standards, the Model Codes and normally require products to bear fire labels. Such products must conform in every respect to the labeling or approval requirements of the certification organization.

The architect must be knowledgeable of the local code as well as the regulations imposed by the owner or the insurance company. The architect must analyze and interpret the relevant requirements and designate, in the door schedule, which openings are to be rated, the level of protection required and the materials that are acceptable. The architect must resolve, in advance, such conflicts as may exist between local codes and labeling requirements and clearly specify what is to be provided, so as to avoid any possible misunderstandings.

The hardware specifier is responsible for ensuring that the appropriate type of hardware is used. The door manufacturer, who is nationally oriented and is often located at some distance from the job site, cannot be expected to be familiar with all local requirements unless the architect provides this information. It is the architect's responsibility, therefore, not only to see that the building is properly protected from the danger of fire spread, but to fully inform the door manufacturer as to what is required, under local regulations, to accomplish this.

### **Guidelines for Proper Usage**

The following guidelines should be observed:

1. Ensure that the door schedule includes all essential information regarding fire doors, such as the mandated test Standard, the required fire endurance rating, temperature rise rating, type of door design, desired jamb and trim profiles and type of frame anchorage.
2. Specify that doors, frames and hardware be supplied by manufacturers subscribing to a nationally recognized certification, labeling or approval services with a Follow-Up Service program.
3. Specify that all doors and frames have the proper fire labels or approval symbols attached. Use only labeled frames with labeled doors. Use only listed hardware with labeled doors.
4. Ensure that sizes of doors and frames do not exceed those allowed.
5. If the doors and/or frames are to be glazed, be sure that the dimensions and areas are within pre-

scribed limits, that only labeled glazing material is used and that all glazing stops are of approved material.

6. Ensure that the proper types of hardware (hinges, latches, closers, etc.) are specified and that no chains, hook-backs or other devices are installed to prevent the free closing and latching of the door at any time.
7. If unique designs of doors or frames are contemplated, acceptability may have to be proven by testing or evaluation. Such processes are time consuming and costly.
8. If special frame profiles are used, ensure that the profile dimensions do not exceed fire rating requirements and are compatible with the specified hardware.
9. Ensure that combustible floor coverings do not extend through openings protected by 3 hour fire-rated door assemblies.
10. Check the requirements of both the local code and the insurance company involved for any other restrictive regulations.
11. Ensure that door and frame labels are not altered, removed or relocated in the field.
12. Hardware changes or any alterations to doors or frames made in the field must be done under a recognized certification authority field inspection program.

### **Ranges of Types and Sizes Available**

Hollow metal fire doors of all ratings and various designs, as well as a variety of frame types, are supplied by member manufacturers, some offering a wide variety, others a more limited choice. Because the requirements for 3 hour assemblies are more severe than those of assemblies having lower ratings, the choice in such locations is limited to flush unglazed doors or in certain jurisdictions, lights not exceeding 100 square inches (0.065 square meters). (See Table 4) The range of types available for the other ratings is much broader, and since each manufacturer has its own methods of construction, each offers a somewhat different selection. As well, since the development and improvement of fire door design is an ongoing process, and the selection of products changes from time to time.

The leading manufacturers of fire rated doors and frames are members of the Hollow Metal Manufacturers Association. Representative types of doors and frames offered by member companies are shown on the following pages. Each company provides its own product literature describing in detail the items it produces. Before specifying fire door assemblies the literature of the intended supplier should always be consulted. The NAAMM website ([www.naamm.org](http://www.naamm.org)) contains a roster with links to member companies.

## UL AND WHI LABELS USED ON HOLLOW METAL FIRE DOORS

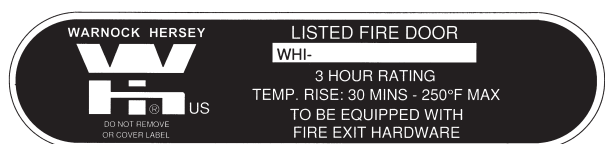
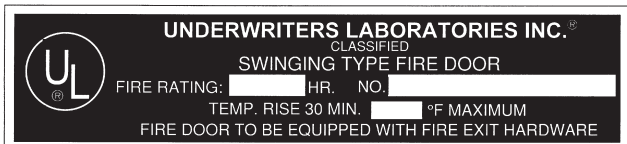
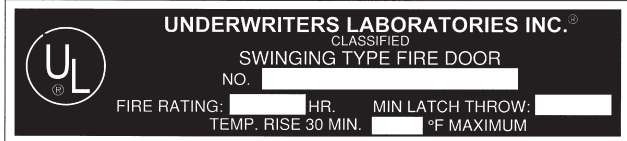
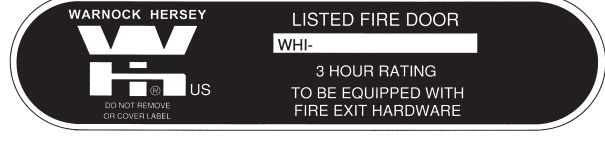
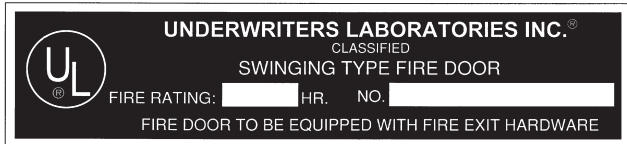
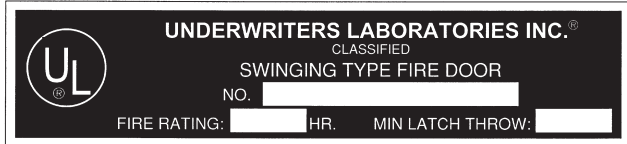

## UL AND WHI LABELS USED ON FIRE DOOR FRAME PRODUCT

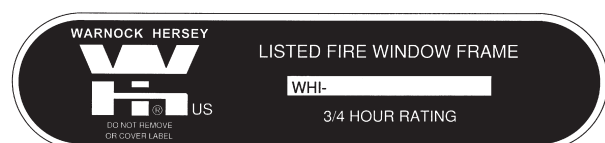
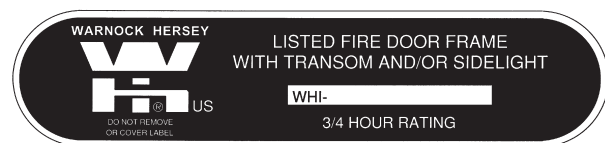
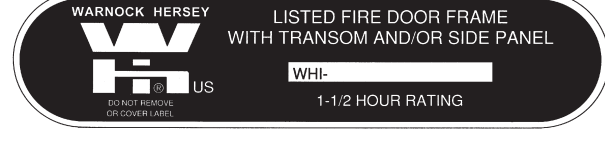

Note : Manufacturer must also be identified on each product, either by:

- a supplementary label bearing the manufacturer's name and address,
- a combination label bearing the required information along the manufacturer's name and address or
- a label bearing the manufacturer's procedure, file or reference number

**REPRESENTATIVE TYPES OF HOLLOW METAL FIRE DOORS** (See Table 4 for Limitations)

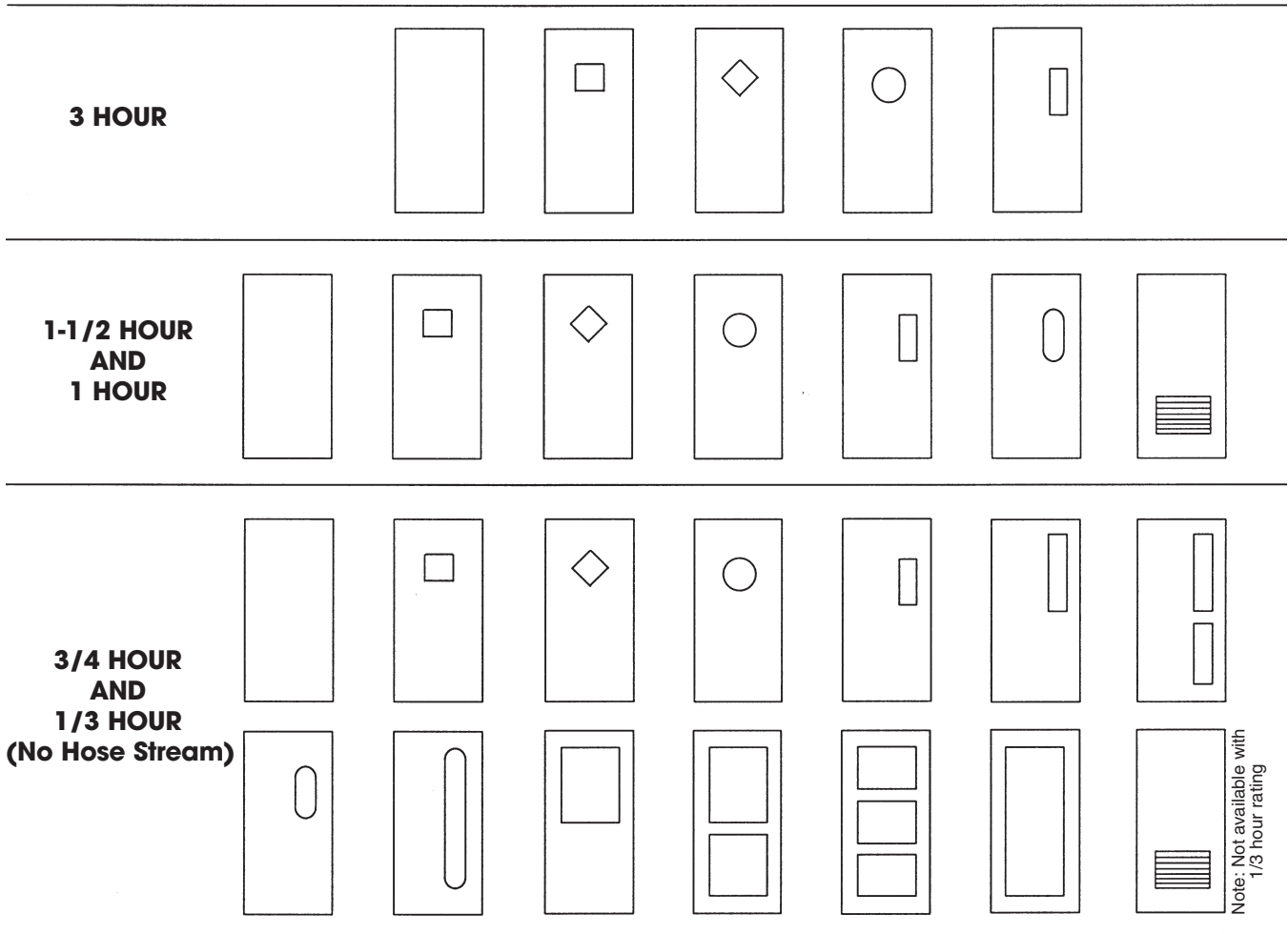

**LABELED GLAZING MATERIALS FOR HOLLOW METAL FIRE DOORS**

Table 4 summarizes, by fire endurance rating, the maximum areas, widths and heights of commercially available glazing materials labeled by either UL or WHI for use in hollow metal fire doors. Users are advised to consult individual glazing manufacturer’s listings for specific limitations, restrictions and requirements.

Labeled Material		3 Hours	1-1/2 Hours	1 Hour	3/4 Hour	1/3 Hour (NHS <sup>(a)</sup> )
Laminated or Solid Ceramic Glazing	Area	100 in <sup>2</sup> (0.065m <sup>2</sup> ) <sup>(b,c)</sup>	4032 in <sup>2</sup> (2.6m <sup>2</sup> ) <sup>(c)</sup>	4136 in <sup>2</sup> (2.67m <sup>2</sup> ) <sup>(c)</sup>	4136 in <sup>2</sup> (2.67m <sup>2</sup> ) <sup>(d)</sup>	4738 in <sup>2</sup> (3.1m <sup>2</sup> ) <sup>(d)</sup>
	Width	12" (305 mm)	48" (1219 mm)	50-3/4"(1289 mm)	50-3/4"(1289mm)	93-1/2" (2375mm)
	Height	33" (838 mm)	84" (2134 mm)	81-1/2"(2134 mm)	81-1/2"(2134 mm)	93-1/2" (2375 mm)
Specialized Wired Glass	Area		2208 in <sup>2</sup> (1.43m <sup>2</sup> ) <sup>(c)</sup>	2208 in <sup>2</sup> (1.43m <sup>2</sup> ) <sup>(c)</sup>	2856 in <sup>2</sup> (1.84m <sup>2</sup> ) <sup>(d)</sup>	2856 in <sup>2</sup> (1.84m <sup>2</sup> ) <sup>(d)</sup>
	Qty of Lights	Not Permitted	Up to 4 lights	Up to 4 lights	No Limit	No Limit
	Width		12" (305 mm)	12" (305 mm)	34" (864 mm)	34" (864 mm)
	Height		46"(1168 mm)	46"(1168 mm)	84" (2134 mm)	84" (2134 mm)
1/4" (6 mm) Wired Glass	Area		100 in <sup>2</sup> (0.065m <sup>2</sup> ) <sup>(c)</sup>	100 in <sup>2</sup> (0.065m <sup>2</sup> ) <sup>(c)</sup>	1296 in <sup>2</sup> (0.84m <sup>2</sup> ) <sup>(d)</sup>	3289 in <sup>2</sup> (2.12m <sup>2</sup> ) <sup>(d)</sup>
	Width	Not Permitted	12" (305 mm)	12" (305 mm)	54" (1372 mm)	36" (914 mm)
	Height		33" (838 mm)	33" (838 mm)	54" (1372 mm)	92" (2337 mm)

(a) : NHS = No Hose Stream

(b) : Where permitted by the AHJ

(c) : Maximum area per leaf

(d) : Maximum area per light

Note : Not all types or maximum sizes are available from all manufacturers

TABLE 4

**REPRESENTATIVE TYPES OF FIRE DOOR FRAME PRODUCT**

**3 HOUR**

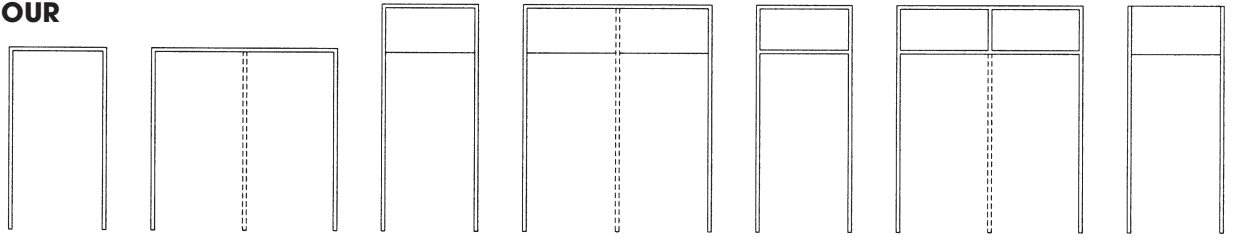

Three Sided Frames  
(Center Mullion Optional)

Frames with 1-3/4" (44mm) Hollow  
Metal Panels (no transom bar)

Transom Frames with 1-3/4" (44mm)  
Hollow Metal Panels or 3/8" to 3/4"  
(9.5 to 19mm) Solid Panels

Panel at Head  
of Frame

**1-1/2 HOUR AND 1 HOUR** Any 3 Hour Frame Assembly Plus:

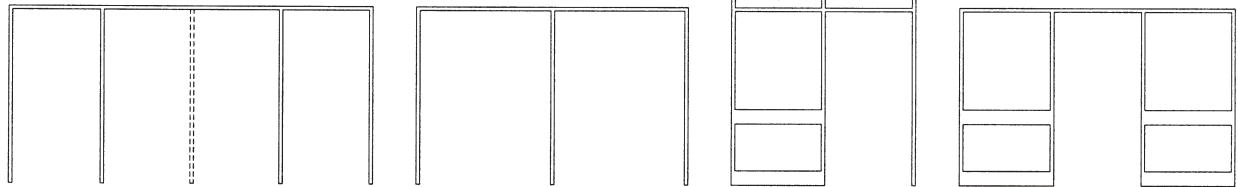

Multiple Opening Frame Assemblies (Combinations of Singles and/or Pairs)

Sidelight Frames with 3/8" to 3/4" (9.5 to 19mm)  
Solid Panels or Labeled Glazing Materials

**3/4 HOUR AND 1/3 HOUR (No Hose Stream)** Any 3, 1-1/2 or 1 Hour Frame Assembly Plus:

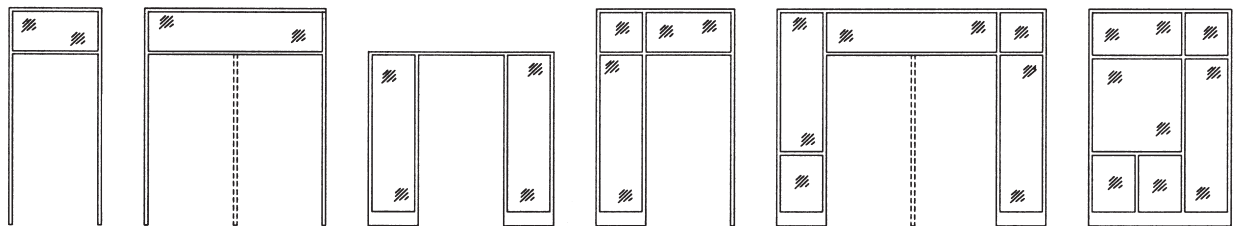

Transom Frames with  
Labeled Glazing Materials

Sidelight Frames with Labeled Glazing Materials and/or Panels

Windows with Labeled  
Glazing Materials

**LABELED MATERIALS FOR TRANSOM, SIDELIGHT AND WINDOW ASSEMBLIES**

Table 5 summarizes by fire endurance rating, the maximum individual areas, widths and heights of commercially available materials labeled by either UL or WHI for use in transom, sidelight and window assemblies. Users are advised to consult individual glazing manufacturer's listings for specific limitations, restrictions and requirements.

Labeled Material		3 Hours	1-1/2 Hours	1 Hour	3/4 Hour	1/3 Hour (NHS <sup>(a)</sup> )
Panels	Area	4608 in <sup>2</sup> (2.97m <sup>2</sup> )	4608 in <sup>2</sup> (2.97m <sup>2</sup> )	4608 in <sup>2</sup> (2.97m <sup>2</sup> )	4608 in <sup>2</sup> (2.97m <sup>2</sup> )	4608 in <sup>2</sup> (2.97m <sup>2</sup> )
	Width	96" (2438 mm)	96" (2438 mm)	96" (2438 mm)	96" (2438 mm)	96" (2438 mm)
	Height	48" (1219 mm)	48" (1219 mm)	48" (1219 mm)	48" (1219 mm)	48" (1219 mm)
Laminated or Solid Ceramic Glazing	Area		1860 in <sup>2</sup> (1.2m <sup>2</sup> )	4290 in <sup>2</sup> (2.77m <sup>2</sup> )	4290 in <sup>2</sup> (2.77m <sup>2</sup> )	4738 in <sup>2</sup> (3.06m <sup>2</sup> )
	Width	Not Permitted	47-1/4" (1200 mm)	78" (1981 mm)	78" (1981 mm)	93-1/2"(2375mm)
	Height		47-1/4" (1200 mm)	78" (1981 mm)	78" (1981 mm)	93-1/2"(2375 mm)
Specialized Wired Glass	Area				4704 in <sup>2</sup> (3.03m <sup>2</sup> )	4704 in <sup>2</sup> (3.03m <sup>2</sup> )
	Width	Not Permitted	Not Permitted	Not Permitted	106" (2692 mm)	106" (2692 mm)
	Height				106" (2692 mm)	106" (2692 mm)
1/4" (6 mm) Wired Glass	Area				1296 in <sup>2</sup> (0.84 m <sup>2</sup> )	5268 in <sup>2</sup> (3.4m <sup>2</sup> )
	Width	Not Permitted	Not Permitted	Not Permitted	54" (1372 mm)	110-3/8"(2804mm)
	Height				54" (1372 mm)	110-3/8"(2804mm)

(a) : NHS = No Hose Stream Note : Not all types or maximum sizes are available from all manufacturers

TABLE 5

## REFERENCES

### BUTTS AND HINGES, ANSI A156.1

American National Standards Institute, Inc.  
11 W. 42nd Street  
New York City, NY 10036  
Telephone : (212) 642-4900  
E-mail : [info@ansi.org](mailto:info@ansi.org)  
Website : <http://www.ansi.org>

### LABORATORY MEASUREMENT OF AIRBORNE SOUND TRANSMISSION LOSS OF BUILDING PARTITIONS, ASTM E 90

### CLASSIFICATION FOR DETERMINATION OF SOUND TRANSMISSION CLASS, ASTM E 413

American Society for Testing & Materials  
100 Barr Harbor Drive  
West Conshohocken, PA 19428-2959  
Telephone : (610) 832-9585  
E-mail : [service@astm.org](mailto:service@astm.org)  
Website : <http://www.astm.org>

### HARDWARE FOR LABELED FIRE DOORS

Door and Hardware Institute  
14150 Newbrook Drive  
Suite 200  
Chantilly, VA 20151-2222  
Telephone : (703) 222-2010  
E-mail : [publications@dhi.org](mailto:publications@dhi.org)  
Website : <http://www.dhi.org>

### FACTORY MUTUAL APPROVAL GUIDE

(published annually with quarterly supplements)

Factory Mutual Engineering & Research Corporation  
1151 Boston-Providence Turnpike  
Norwood, MA 02062  
Telephone : (617) 255-4682  
E-mail : -  
Website : <http://www.factorymutual.com>

### HOLLOW METAL TECHNICAL AND DESIGN MANUAL

National Association of Architectural  
Metal Manufacturers  
8 South. Michigan Avenue  
Suite 1000  
Chicago, IL 60603  
Telephone : (312) 332-0405  
E-mail : [naamm@gss.net](mailto:naamm@gss.net)  
Website : <http://www.naamm.org>

### STANDARD FOR FIRE DOORS AND FIRE WINDOWS, ANSI/NFPA 80

### CODE FOR SAFETY TO LIFE FROM FIRE IN BUILDINGS AND STRUCTURES, ANSI/NFPA 101

### RECOMMENDED PRACTICE FOR THE INSTALLATION OF SMOKE-CONTROL DOOR ASSEMBLIES, NFPA 105

### STANDARD ON TYPES OF BUILDING CONSTRUCTION, ANSI/NFPA 220

### STANDARD METHODS OF FIRE TESTS OF DOOR ASSEMBLIES, ANSI/NFPA 252

### STANDARD FOR FIRE TEST FOR WINDOW AND GLASS BLOCK ASSEMBLIES, ANSI/NFPA 257

National Fire Protection Association  
One Batterymarch Park  
P.O. Box 9101  
Quincy, MA 02269-9101  
Telephone : (617) 770-3000  
E-mail : [custserv@nfpa.org](mailto:custserv@nfpa.org)  
Website : <http://www.nfpa.org>

### FIRE TESTS FOR WINDOW ASSEMBLIES, ANSI/UL 9

### FIRE TESTS OF DOOR ASSEMBLIES, ANSI/UL 10b

### FIRE TESTS OF DOOR ASSEMBLIES UNDER POSITIVE PRESSURE, ANSI/UL 10c

### BULLET RESISTING EQUIPMENT, ANSI/UL 752

### AIR LEAKAGE TESTS OF DOOR ASSEMBLIES, UL 1784

### BUILDING MATERIALS DIRECTORY

(published annually with supplements)

Underwriters' Laboratories, Inc.  
333 Pfingsten Road  
Northbrook, IL 60612  
Telephone : (847) 272-8800  
E-mail : [glogal@ihs.com](mailto:glogal@ihs.com)  
Website : <http://www.ul.com>

### DIRECTORY OF LISTED PRODUCTS

(published annually)

Intertek Testing Services NA Inc/ Warnock Hersey  
3933 US Route 11  
Cortland, NY 10345  
Telephone : (607) 753-6711  
E-mail : [dirlist@itsqs.com](mailto:dirlist@itsqs.com)  
Website : <http://www.its.com>





**HARDWARE FOR  
SWINGING FIRE DOORS**

**CONTENTS**

---

General Hardware Requirements . . . . . 2-2

Builders Hardware for Singles and Pairs of Doors . . . 2-2

    Hinges and Pivots . . . . . 2-2

    Locks, Latches and Deadbolts . . . . . 2-3

    Fire Exit Hardware . . . . . 2-3

    Closers . . . . . 2-4

    Gasketing Materials . . . . . 2-4

    Automatic Door Bottoms . . . . . 2-4

    Protection Plates . . . . . 2-4

Builders Hardware for Pairs of Doors . . . . . 2-4

    Flush Bolts . . . . . 2-4

    Surface Bolts . . . . . 2-4

    Coordinators . . . . . 2-4

    Astragals . . . . . 2-4

Hardware Code Summary . . . . . 2-5

## General Hardware Requirements

Hardware requirements for fire doors are specified in ANSI/NFPA 80, "Standard for Fire Doors and Fire Windows". This Standard refers to hardware for fire doors as "Builders Hardware" and "Fire Door Hardware".

Builders hardware is applied only to swinging doors and consists of the items referenced in Tables 6 and 7. These include: hinges; single, two and three point locks or latches; top and bottom bolts; and door closers. Within the category of "Builders Hardware" is "Fire Exit Hardware".

Fire exit hardware consists of exit devices which have been labeled both for fire and panic protection.

Labeled hardware for fire doors is required for all fire-rated openings from 1/3 hour to 3 hours.

When positive pressure tested doors and frames are specified, hardware tested to ANSI/UL10c or UBC 7-2 (1997) is also required.

The following is a summary of hardware for swinging flush hollow metal doors. The alpha-numeric code shown in parentheses following each hardware item is used in the Fire-Rated Doors and Frames Section to indicate approved devices for different door assemblies.

Hinges and Pivots shall be provided as specified in Table 6.

## Builders Hardware for Singles and Pairs of Doors

### Hinges (Steel)

#### Butt Type

- Full Mortise (H1)
- Half Mortise (H2)
- Half Surface (H3)
- Full Surface (H4)

#### Anchor Type (H5)

#### Mortise, Self Closing Spring Type (H6)

#### Swing Clear Type

- Full Mortise (H7)
- Half Mortise (H8)
- Half Surface (H9)
- Full Surface (H10)

#### Continuous Type

- Edge (H11)
- Half Edge (H12)
- Half Surface (H13)
- Full Surface (H14)

### Pivots - Steel

#### Top, Bottom and Intermediate (H15)

Door Assembly Fire Rating Hours	Maximum Door Size		Minimum Hinge Size		Hinge Type
	Width ft (mm)	Height ft (mm)	Height In. (mm)	Thickness In. (mm)	
3, 1½, ¾, ⅓	4 (1219)	8 (2438)	4½ (114)	0.134 (3.40)	Steel, mortise or surface
3, 1½, ¾, ⅓	4 (1219)	10 (3048)	4½ (114)	0.180 (4.57)	Steel, mortise or surface
1½, ¾, ⅓	3'2 (965)	8 (2438)	6 (152)	0.225 (5.72)	Steel, olive knuckle or paumelle
3, 1½, ¾, ⅓	4 (1219)	10 (3048)	4 (102)	0.225 (5.72)	Steel Pivots (including top, bottom & intermediate)
1½, ¾, ⅓	3 (914)	5 (1524)	4 (102)	0.130 (3.30)	Steel, mortise or surface
1½, ¾, ⅓	2 (610)	3 (914)	3 (76)	0.092 (2.34)	Steel, mortise or surface
3, 1½, ¾, ⅓	3 (914)	7 (2134)	4 (102)	0.105 (2.67)	Steel, mortise or surface (labeled self-closing spring type)

#### Notes

- (1): Doors up to 5 feet (1524 mm) in height shall be provided with two hinges and an additional hinge for each additional 2'6" (762 mm) of door height or fraction thereof. The distance between hinges shall not exceed 2'6" (762 mm) unless tested otherwise. Where self closing spring type hinges are used, at least two shall be provided for each leaf.
- (2): All hinges or pivots, except spring hinges, shall be of the ball bearing type. Hinges or pivots employing other than anti-friction bearing surfaces shall be permitted if they meet the requirements of ANSI A156.1, "Standard for Butts and Hinges". Self closing spring hinges shall be labeled.
- (3): 4½ in. (114 mm) high, 0.180 in. (4.57 mm) thick hinges shall be permitted for use on wide and heavy doors or doors that are subjected to heavy use or unusual stress.
- (4): Some manufacturers can provide fire doors with hinges of lighter weight (thickness) that are not of the ball bearing type where they are part of a labeled assembly, meet the test requirements of ANSI A156.1, "Standard for Butts and Hinges" and have been tested to a minimum of 350,000 cycles.
- (5): Pivot sets made up of components that are smaller or of a lighter weight (thickness) than shown above shall be permitted to be used, provided they meet the requirements of ANSI A156.4, "Door Controls (Closers)" and are in accordance with the manufacturer's label service procedure.

TABLE 6

MORTISE, SURFACE AND SELF CLOSING SPRING HINGES OR PIVOTS FOR 1-3/4" (44 mm) THICK DOORS<sup>(1-5)</sup>

**Lock, Latches and Deadbolts**

- Mortise Latch or Lock (Single and Three Point) (L1)
- Cylindrical (Bored) Latch or Lock (L2)
- Pre-Assembled Latch or Lock (L3)
- Mortise Deadlock (L4) (See Exceptions)
- Cylindrical (Bored) Deadlock (L5) (See Exceptions)
- Electromechanical/Electric Strike (L6)
- Electromechanical/Electric Latch (L7)

**Fire Exit Hardware**

Single Doors

- Rim Type (EH1)
- Mortise Type (EH2)

Two Single Doors with Welded or Removable Mullion

- Rim Type (EH1)
- Mortise Type (EH2)

Pairs of Doors

- Rim Type with Removable Mullion Behind Doors (EH1)
- Mortise Type (EH2)
- Surface Vertical Rod Type (EH3)
- Concealed Vertical Rod Type (EH4)

All single doors and the active leaf of all pairs of fire doors are permitted to be provided with an active latch bolt (one that cannot be held in a retracted position) as specified in Table 7.

Exception: Doors other than those used in means of egress are permitted to be provided with dead bolts in addition to the active latch or bolts or as otherwise permitted by the Authority Having Jurisdiction.

Exception: Locks with dead bolts which are interconnected with latch bolts and retract when the latch bolt is retracted are permitted to be used on fire doors within a means of egress.

Exception: Latching arrangements that do not provide positive latching in the normal mode are permitted to be used provided that in a fire emergency, the door becomes positively latched by means of an automatic fail-safe device that is activated by an automatic fire detector.

Where both leafs are required for exit purposes, they shall be provided with labeled fire exit hardware.

Exception: Where acceptable to the Authority Having Jurisdiction, pairs of doors not provided with an astragal are permitted to have labeled fire exit hardware and an open back strike installed on the inactive leaf and either labeled fire exit hardware or any labeled latch capable of being opened by one obvious operation from the egress side installed on the active leaf.

Where a pair of doors is needed for the movement of equipment and where the inactive leaf of pair of doors is not required for exit purposes, labeled top and bottom and self-latching or automatic flush bolts or labeled two point latches are acceptable.

Exception: Manually operated, labeled top and bottom flush or surface bolts on the inactive leaf of a pair of doors shall be permitted to be used when acceptable to the Authority Having Jurisdiction provided they do not pose a hazard to life safety. This provision limits their use to rooms not normally occupied by humans (e.g. transformer vaults, storage rooms). The inactive leaf does not require a closer.

Many hardware manufacturers produce electrically operated and/or electronic devices that have been tested and certified from both an electrical and fire protection standpoint and are eligible for use in hollow metal fire door assemblies.

Door Assembly	Single Swing Doors		Pairs of Doors		Inactive Leaf
	Maximum Door Height	Minimum Latch Throw <sup>(a)</sup>	Maximum Door Height	Minimum Latch Throw <sup>(a)</sup>	
Fire Rating Hours	feet (mm)	inches (mm)	feet (mm)	inches (mm)	
3, 1½, ¾, ½	10 (3048)	½ (12.7)	10 (3048)	¾ (19)	Labeled Two-Point Latching Device or Top and Bottom Bolts

(a) : Unless otherwise tested

TABLE 7  
LATCHING DEVICES FOR SWINGING HOLLOW METAL DOORS

## Closers

- Surface Mounted on Hinge Face of Door (C1)
- Concealed in Door with Exposed Arm (C2)
- Surface Mounted on Stop Face of Door (C3)
- Concealed in Head with Concealed Arm (C4)
- Concealed in Head with Exposed Arm (C5)
- Concealed in Transom Bar (C6)
- Floor Mounted for Hinged Doors (C7)
- Floor Mounted for Offset Pivoted Doors (C8)
- Holders (must have UL/WHI approved release devices)

## Gasketing Materials

Gasketing or weatherstripping of any kind on fire doors or frames shall be furnished only in accordance with the manufacturer's published listings.

Exception: Where acceptable to the Authority Having Jurisdiction, gasketing of noncombustible or limited combustible material (see ANSI/NFPA 220 "Standard on Types of Building Construction") may be applied to the frame provided closing and latching of the door are not inhibited.

Labeled gasketing materials are intended for installation with fire doors, fire door frames or both, as specified in the individual listings. These materials may be installed at the manufacturer's plant or in the field in accordance with the instructions provided with the product.

These materials have been investigated to determine that their installation does not adversely affect the fire resistance performance of the door and frame assembly. The performance of gasketing is observed during the fire and hose stream test to ensure that flaming does not occur on the unexposed surface of the door assemblies. It is important to note, however, that the ANSI/UL 10b and ANSI/NFPA 252 standard fire test do not include evaluation of the door assembly relative to preventing the passing of smoke or other products of combustion through or around the assembly.

## Automatic Door Bottoms

- Surface Mounted (D1)
- Half Mortised (D2)
- Full Mortised (D3)

## Protection Plates

The top of the plate shall be a maximum of 16 inches (406 millimeters) above the bottom of the door unless otherwise tested. Such plates may be on both door faces. No other plates shall be installed.

## Builders Hardware for Pairs of Doors

### Flush Bolts

- Manual Type (FB1)
- Self - Latching Type, Edge Mounted Operator (FB2)
- Self - Latching Type, Surface Mounted Operator (FB3)
- Automatic Type (FB4)

### Surface Bolts

- Manual Type (SB1)

### Coordinators

- Surface Mounted Type (CO1)
- Mortised Type (CO2)

### Astragals

Pairs of doors having a fire protection rating greater than 1-1/2 hours shall have an over-lapping astragal. Doors swinging in pairs within a means of egress shall not be equipped with astragals that inhibit the free use of either leaf. Pairs of doors in other locations shall have at least one astragal attached in place so as to project approximately 3/4 inch (19 millimeters) or as otherwise indicated in the individual's published listings.

The foregoing requirement essentially rules out the use of overlapping astragals within a Means of Egress and restricts the hardware to the following:

1. Two vertical rod devices (surface or concealed)
2. One door - Surface or concealed vertical rod device and open back strike  
Other door - Latch or mortise exit device

For pairs of doors where only one leaf is needed to satisfy egress requirements, the active door may have a latch or mortise fire exit hardware. The inactive leaf may have self-latching or automatic flush bolts or two point latch. A closed back strike would be used on the inactive door. An overlapping astragal may or may not be used as required by the individual manufacturers' listing. A closer is required on both doors and a coordinating device would be required in rooms of human occupancy.

Only labeled hardware meeting both life safety and fire protection requirements shall be used. Refer to UL's "Building Materials Directory" or WHI's "Directory of Listed Products" for labeled hardware.

## HARDWARE CODE SUMMARY

### Hinges (Steel)

- H1 - Full Mortise Butt Hinge
- H2 - Half Mortise Butt Hinge
- H3 - Half Surface Butt Hinge
- H4 - Full Surface Butt Hinge
- H5 - Anchor Hinge
- H6 - Mortise Self Closing Spring Hinge
- H7 - Full Mortise, Swing Clear Hinge
- H8 - Half Mortise, Swing Clear Hinge
- H9 - Half Surface, Swing Clear Hinge
- H10 - Full Surface, Swing Clear Hinge
- H11 - Edge Mounted Continuous Hinge
- H12 - Half Edge Mounted Continuous Hinge
- H13 - Half Surface Mounted Continuous Hinge
- H14 - Full Surface Mounted Continuous Hinge
- H15 - Offset Pivot Sets

### Locks, Latches and Deadbolts

- L1 - Mortised Latch or Lock
- L2 - Cylindrical (Bored) Latch or Lock
- L3 - Pre-Assembled Latch or Lock
- L4 - Mortised Deadlock
- L5 - Cylindrical (Bored) Deadlock
- L6 - Electromechanical/Electric Strike
- L7 - Electromechanical/Electric Latch

### Fire Exit Hardware

- EH1 - Rim Type
- EH2 - Mortise Type
- EH3 - Surface Vertical Rod Type
- EH4 - Concealed Vertical Rod Type

### Closers (Overhead)

- C1 - Surface Mounted on Hinge Face of Door
- C2 - Concealed in Door with Exposed Arm
- C3 - Surface Mounted on Stop Face of Door
- C4 - Concealed in Head with Concealed Arm
- C5 - Concealed in Head with Exposed Arm
- C6 - Concealed in Transom Bar

### Closers (Floor)

- C7 - For Hinged Doors
- C8 - For Offset Pivoted Doors

### Flush Bolts

- FB1 - Manual Type
- FB2 - Self-Latching Type, Edge Mounted Operator
- FB3 - Self-Latching Type, Surface Mounted Operator
- FB4 - Automatic Type

### Surface Bolts

- SB1 - Manual Type

### Coordinators

- CO1 - Surface Mounted Type
- CO2 - Mortised Type

### Automatic Door Bottoms

- D1 - Surface Mounted
- D2 - Half Mortised
- D3 - Full Mortised



**FIRE-RATED DOORS AND FRAMES**

**CONTENTS**

---

Basic Hollow Metal Fire Doors . . . . .	3-2
Pairs of Fire Doors in Means of Egress . . . . .	3-3
Temperature Rise Rated Fire Doors . . . . .	3-4
Double Egress Fire Doors and Frames . . . . .	3-5
Stainless Steel Fire Doors . . . . .	3-6
Dutch Hollow Metal Fire Doors . . . . .	3-7
Louvered Hollow Metal Fire Doors . . . . .	3-8
Three-Sided Frames . . . . .	3-9
Multiple Opening Frames and Transom Frames . . . . .	3-10
Frames with 1-3/4" (44 mm) Transom Panels without Transom Mullion . . . . .	3-11
Transom Frames with 1-3/4" (44 mm) Transom Panels and Transom Mullion . . . . .	3-12
Transom Frames with Transom Panels and Transom Mullion . . . . .	3-13
Transom Frames - Glazed . . . . .	3-14
Sidelight Frames - Glazed or Paneled . . . . .	3-15
Window Frames - Glazed or Paneled . . . . .	3-16
Special Purpose Fire Door and Frame Assemblies	
Sound Control . . . . .	3-17
Detention Security . . . . .	3-18
Bullet-Resistant . . . . .	3-19
Radiation Shielding . . . . .	3-20
Profiles for Fire-Rated Frame Product . . . . .	3-21
Anchors for Fire-Rated Frame Product . . . . .	3-22
Summary - Hollow Metal Fire Doors . . . . .	3-24
Summary - Fire Door Frame Product . . . . .	3-25



## BASIC HOLLOW METAL FIRE DOORS

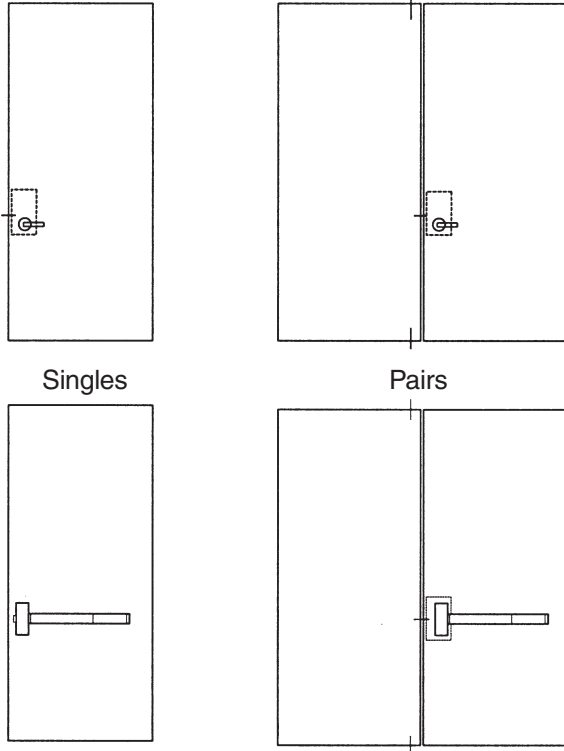

**Product :**

1-3/4" (44 mm) thick doors, swinging singly or in pairs, in ratings up to 3 hour fire protection

**Maximum Door Opening :**

Singles : 4'0" x 10'0" (1219 x 3048 mm)

Pairs : 8'0" x 10'0" (2438 x 3048 mm)

Note : Pairs may be provided without astragal in ratings up to 1-1/2 hour. For 3 hour rated pairs an overlapping astragal is required.

**Maximum Leaf Size :**

4'0" x 10'0" (1219 x 3048 mm)

**Glazing :**

Refer to Section 1, Table 4, Page 1-9 for requirements

**Frames :**

Any fire-rated frame shall be used.

**Specifications :**

Refer to NAAMM/HMMA 860 and 861 for detailed specifications or consult individual member companies

**Hardware :** Refer to Section 2, Page 2-5 for Hardware Code Summary

Hardware(2439 mm)	Door Height	
	8'0" (2438 mm) and less	Over 8'0" (2438 mm) to 10'0" (3048 mm)
Hinges	H1 to H14 <sup>(1)</sup>	H1 to H5 and H7 to H14
Offset Pivots	H15	H15
Locks and Latches	L1, L2 and L3	Singles : L1 and L2 Pairs : L1 only
Deadbolts <sup>(2)</sup>	L4 and L5	L4 and L5
Latch Throw <sup>(3)</sup>	Singles : 1/2" (12.7 mm) Pairs : 3/4" (19 mm)	3/4" (19 mm)
Fire Exit Hardware	Singles : EH1 and EH2 Pairs <sup>(4)</sup> : EH2 to EH4	Singles : EH1 and EH2 Pairs <sup>(4)</sup> : EH2 to EH4
Flush Bolts <sup>(5)</sup>	FB1 to FB4	FB1 to FB4
Overhead Closers	C1 to C6	C1 to C6
Floor Closers	C7 and C8	C7 and C8

Notes :

- (1) : Mortise Self Closing Spring Hinges (H6) are limited to 3'0" x 7'0" (914 x 2134 mm) openings
- (2) : All single doors and active leaf of pairs of doors shall be provided with an active latch bolt. Only labeled locks and latches meeting both life safety and fire protection requirements shall be used. For doors other than those in a means of egress, deadbolts shall be permitted in addition to the active latch bolt or as otherwise permitted by the Authority Having Jurisdiction. See ANSI/NFPA 80.
- (3) : Latch throws shown are as per ANSI/NFPA 80. Some manufacturers are permitted to provide doors using smaller latch throws
- (4) : Pairs of doors where both leaves are required for exit purposes shall be provided with labeled fire exit hardware.  
Exception : When acceptable to the Authority Having Jurisdiction, pairs of doors not provided with an astragal are permitted to have labeled fire exit hardware and an open back strike installed on the inactive leaf and either labeled fire exit hardware or any labeled latch capable of being operated by one obvious operation from the egress side installed on the active leaf.
- (5) : Manually operated, labeled top and bottom flush bolts (FB1) or surface bolts (SB1) on the inactive leaf of a pair of doors shall be permitted when acceptable to the Authority Having Jurisdiction. This provision limits their use to rooms not normally occupied by humans (e.g. : transformer vaults, storage rooms). The inactive leaf does not require a closer.

## PAIRS OF HOLLOW METAL FIRE DOORS IN A MEANS OF EGRESS

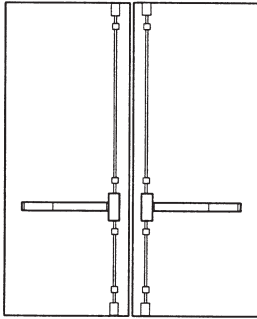

Combination 1

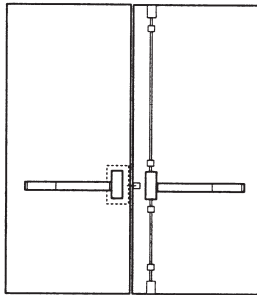
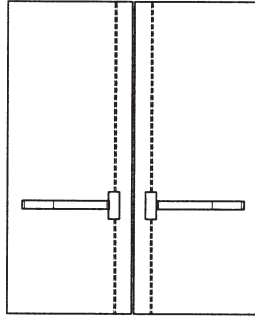

Combination 2

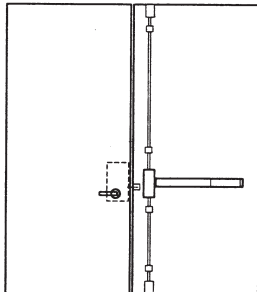
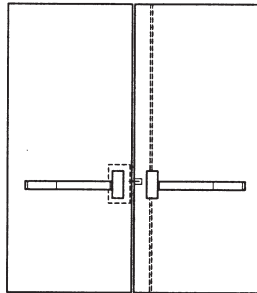

Combination 3

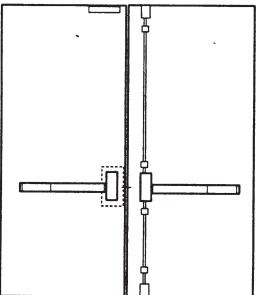
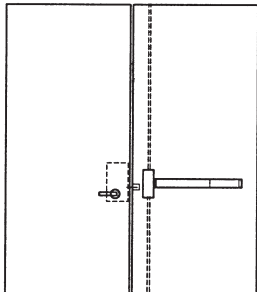

Combination 4

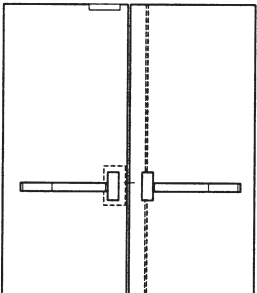

### Product :

1-3/4" (44 mm) thick pairs of doors, swinging in the same direction, in a means of egress, where both leaves are required for exit purposes, without astragal, in ratings up to 1-1/2 hour fire protection or with overlapping astragal up to 3 hour fire protection rating.

Four combinations of hardware are possible to satisfy the requirement that both leaves act as exit doors. Only Combination 4 is eligible for 3 hour fire protection rating.

### Maximum Door Openings :

8'0" x 10'0" (2438 x 3048 mm)

### Maximum Leaf Sizes :

4'0" x 10'0" (1219 x 3048 mm)

### Latching Hardware <sup>(1)</sup> :

Combination 1 : Surface (EH3) or concealed (EH4) vertical rod fire exit hardware on each leaf.

Combination 2 : Surface (EH3) or concealed (EH4) vertical rod fire exit hardware with an open back strike on one leaf. Mortise (EH2) fire exit hardware on other leaf.

Combination 3 : Surface (EH3) or concealed (EH4) vertical rod fire exit hardware with an open back strike on one leaf. Any labeled latch (L1, L2 or L3) capable of being opened by one obvious operation from the egress side of the other leaf, where acceptable to the Authority Having Jurisdiction.

Combination 4 : Surface (EH3) or concealed (EH4) vertical rod fire exit hardware with strike on one leaf. Mortise (EH2) fire exit hardware, coordinator (CO1 or CO2), carry bar and over-lapping astragal on other leaf.

### Other Hardware :

Refer to Section 2, Page 2-5 for Hardware Code Summary

Hinges : H1 to H5 and H7 to H14

Offset Pivots : H15

Locks and Latches : L1, L2, L3 (for Combination 3 only)

Latch Throw <sup>(2)</sup> : 3/4" (19 mm) minimum

Flush Bolts : Not permitted

Overhead Closers : C1 to C6

Floor Closers : C7 and C8

### Glazing :

Refer to Section 1, Table 4, Page 1-9 for requirements

### Frames :

Any fire-rated frame shall be used.

### Specifications :

Refer to NAAMM/HMMA 860 or 861 for detailed specifications or consult individual member companies

(1) : Vertical rod fire exit hardware (EH3 and EH4) are available with top rod only

(2) : Latch throws shown are as per ANSI/NFPA 80. Some manufacturers are permitted to provide doors using smaller latch throws.

## TEMPERATURE RISE RATED HOLLOW METAL FIRE DOORS

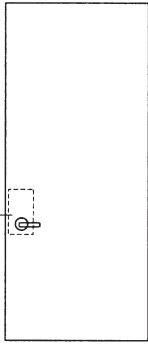

Singles

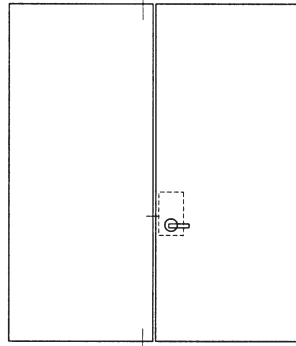

Pairs

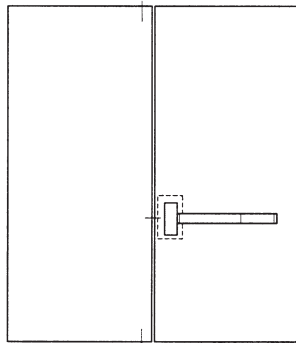
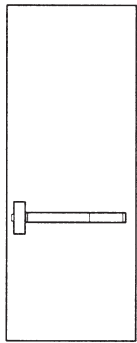

### Frames :

Any fire-rated frame shall be used.

### Specifications :

Refer to NAAMM/HMMA 860 or 861 for detailed specifications or consult individual member companies.

### Product :

1-3/4" (44 mm) thick doors, swinging singly or in pairs, in ratings up to 3 hour fire protection. Typical temperature rise ratings are 650°F (361°C), 450°F (232°C) or 250°F (139°C).

The temperature rise rating (TRR) is in addition to the fire protection rating. It indicates a maximum temperature rise above ambient, developed on the unexposed face of the door at the 30 minute point of a fire test. The lower the TRR, the greater the level of protection. Local Building Codes dictate the level of protection required for openings in specific locations.

### Maximum Door Opening :

Singles : 4'0" x 10'0" (1219 x 3048 mm)

Pairs : 8'0" x 10'0" (2438 x 3048 mm)

Note : Pairs may be provided without astragal in ratings up to 1-1/2 hour. For 3 hour pairs an over-lapping astragal is required.

### Maximum Leaf Size :

4'0" x 10'0" (1219 x 3048 mm)

### Hardware :

Refer to Section 2, Page 2-5 for Hardware Code Summary

Hinges<sup>(1)</sup> : H1 to H14

Offset Pivots : H15

Locks and Latches : L1, L2 and L3

Latch Throw<sup>(2)</sup>

- Singles : 8'0" ht and less: 1/2" (12.7 mm)  
: over 8'0" ht: 3/4" (19 mm)

- Pairs : 3/4" (19 mm)

Deadbolts<sup>(3)</sup> : L4 and L5

Fire Exit Hardware- Singles : EH1 and EH2

- Pairs<sup>(4)</sup> : EH1 to EH4

Overhead Closers : C1 to C6

Floor Closers : C7 and C8

Flush Bolts<sup>(5)</sup> : FB1 to FB4

### Glazing :

All TRR doors with 1/4" (6 mm) labeled wired glass are limited to lights not exceeding 100 square inches (0.065m<sup>2</sup>) per door with the exposed width not exceeding 12" (305 mm) or the exposed height not exceeding 33" (838 mm). Three hour doors are restricted to labeled glazing materials which have been tested to a 3 hour fire protection rating only<sup>(6)</sup>.

(1) : Mortise Self Closing Spring Hinges (H6) are limited to 3'0" x 7'0" (914 x 2134 mm) openings

(2) : Latch throws shown are as per ANSI/NFPA 80. Some manufacturers are permitted to provide doors using smaller latch throws

(3) : All single doors and active leaf of pairs of doors shall be provided with an active latch bolt. Only labeled locks and latches meeting both life safety and fire protection requirements shall be used. For doors other than those in a means of egress, deadbolts shall be permitted in addition to the active latch bolt or as otherwise permitted by the Authority Having Jurisdiction. See ANSI/NFPA 80

(4) : Pairs of doors where both leaves are required for exit purposes shall be provided with labeled fire exit hardware. Exception : When acceptable to the Authority Having Jurisdiction, pairs of doors not provided with an astragal are permitted to have labeled fire exit hardware and an open back strike installed on the inactive leaf and either labeled fire exit hardware or any labeled latch capable of being operated by one obvious operation from the egress side, installed on the active leaf.

(5) : Manually operated, labeled top and bottom flush bolts (FB1) or surface bolts (SB1) on the inactive leaf of a pair of doors shall be permitted when acceptable to the Authority Having Jurisdiction. This provision limits their use to rooms not normally occupied by humans (e.g. : transformer vaults, storage rooms). The inactive leaf does not require a closer.

(6) : Where permitted by the Authority Having Jurisdiction

# DOUBLE EGRESS HOLLOW METAL FIRE DOORS AND FRAMES

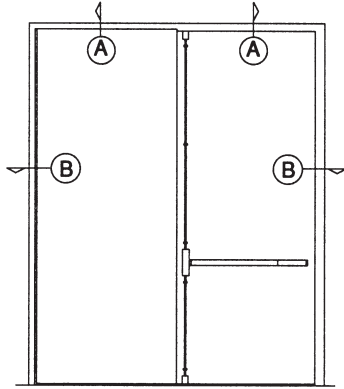

Typical Elevations

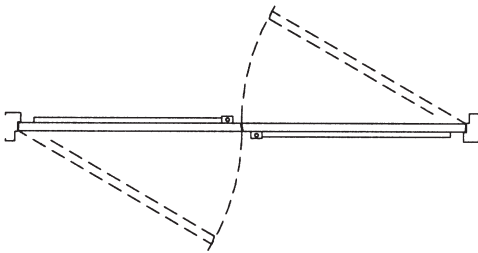
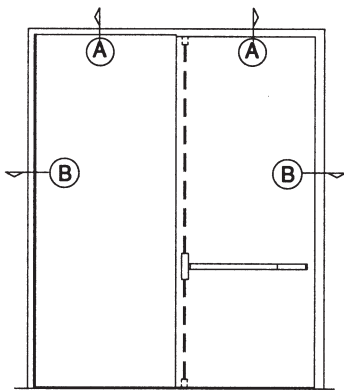

Typical Plan View

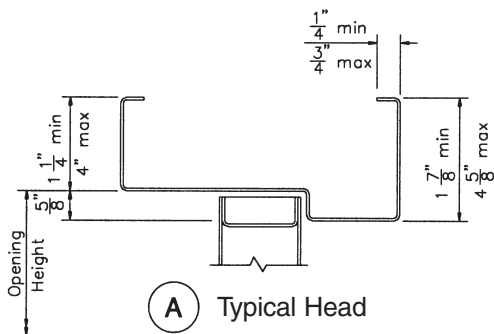

A Typical Head

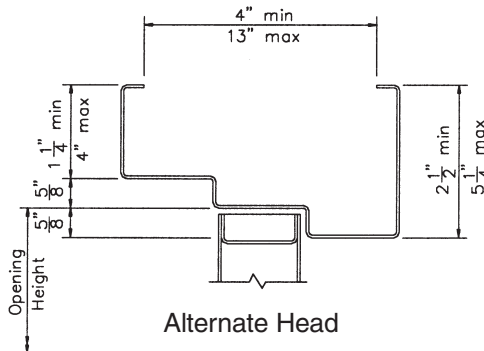

Alternate Head

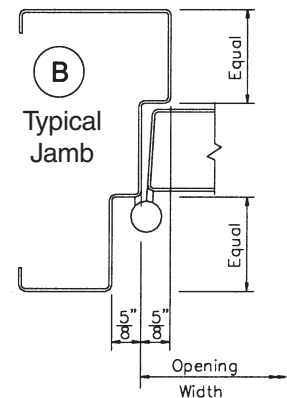

B Typical Jamb

## Product :

1-3/4" (44 mm) thick pairs of doors swinging in opposite directions, in ratings up to 3 hour fire protection.

Double egress assemblies permit traffic flow in both directions through the same opening. Where double egress doors are used for 1-1/2 hour applications or less, they may be installed without astragals. For 3 hour rated double egress doors an over-lapping astragal is required.

## Maximum Door Opening :

8'0" x 10'0" (2438 x 3048 mm)

## Maximum Leaf Size :

4'0" x 10'0" (1219 x 3048 mm)

## Hardware :

Refer to Section 2, Page 2-5 for Hardware Code Summary

Hinges :	H1 to H5, H7 to H14
Offset Pivots :	H15
Locks, Latches, Deadbolts :	Not Permitted
Fire Exit Hardware <sup>(1)</sup> :	EH3 and EH4
Overhead Closers :	C1 to C6
Floor Closers :	C7 and C8
Flush Bolts :	Not Permitted

## Glazing :

Refer to Section 1, Table 4, Page 1-9 for requirements

## Anchors :

Anchors are available for new or existing masonry, poured concrete and wood or steel stud partitions. See "Anchors for Fire-Rated Frames", Page 3-22 for additional information.

## Frames :

A fire-rated frame listed for use with double egress doors is required.

## Specifications :

Refer to NAAMM/HMMA 860 or 861 for detailed specifications or consult individual member companies.

(1) : Both leaves are required for exit purposes, therefore they must be provided with labeled surface (EH3) or concealed (EH4) vertical rod fire exit hardware. There are no exceptions to this for double egress door and frame assemblies.

## STAINLESS STEEL FIRE DOORS

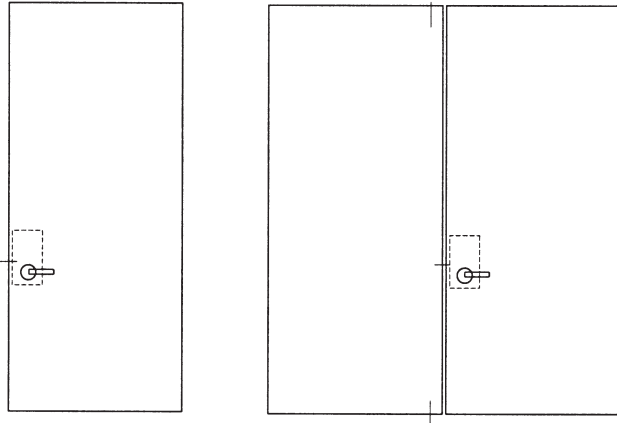

Singles

Pairs

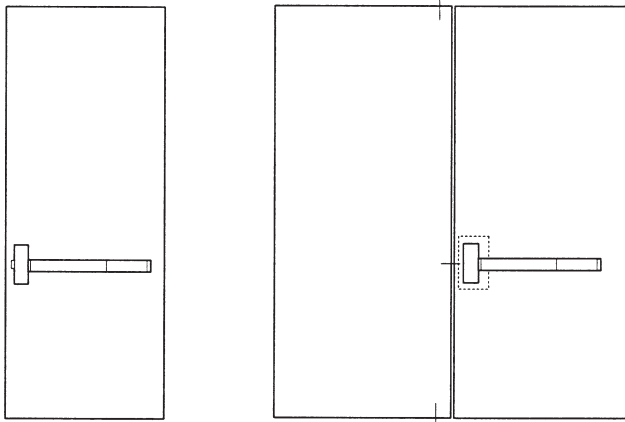

### Product :

1-3/4" (44 mm) thick, swinging singly or in pairs, stainless steel doors, in ratings up to 3 hour fire protection. Available in Types 304, 316 or 430 stainless steel.

### Maximum Door Opening :

Type 304 or 316 - Singles : 4'0" x 8'0" (1219 x 2438mm)  
 Pairs : 8'0" x 8'0" (2438 x 2438mm)

Type 430 - Singles: 4'0" x 10'0" (1219 x 3048mm)  
 Pairs : 8'0" x 10'0" (2438 x 3048 mm)

Note : Pairs may be provided without an astragal in ratings up to 1-1/2 hour. For 3 hour rated pairs an overlapping astragal is required.

### Maximum Leaf Size :

Type 304 or 316 - 4'0" x 8'0" (1219 x 2438 mm)  
 Type 430 - 4'0" x 10'0" (1219 x 3048 mm)

### Hardware:

Refer to Section 2, Page 2-5 for Hardware Code Summary

Hinges<sup>(1)</sup> : H1 to H14  
 Offset Pivots : H15  
 Locks, Latches, Deadbolts<sup>(2)</sup> : L1, L2, L4 and L5  
 Latch Throw<sup>(3)</sup>

- Singles : 8'0" ht and less: 1/2" (12.7 mm)  
 : over 8'0" ht: 3/4" (19 mm)  
 - Pairs : 3/4" (19 mm)

Fire Exit Hardware - Singles : EH1 and EH2  
 - Pairs<sup>(4)</sup> : EH1 to EH4

Overhead Closers : C1 and C3  
 Floor Closers : Not Permitted  
 Flush Bolts<sup>(5)</sup> : FB1 to FB4

### Glazing :

Consult individual member companies for requirements

### Frames :

Any three-sided fire-rated frame shall be used.

### Specifications :

Refer to NAAMM/HMMA 866 for detailed specifications or consult individual member companies.

(1) : Mortise Self Closing Spring Hinges (H6) are limited to 3'0" x 7'0" (914 x 2134 mm) openings

(2) : All single doors and active leaf of pairs shall be provided with an active latch bolt. Only labeled locks and latches meeting both life safety and fire protection requirements shall be used. For doors other than those in a means of egress, deadbolts shall be permitted in addition to the active latch bolt or as otherwise permitted by the Authority Having Jurisdiction. See ANSI/NFPA 80.

(3) : Latch throws shown are as per ANSI/NFPA 80. Some manufacturers are permitted to provide doors using smaller latch throws

(4) : Pairs of doors where both leaves are required for exit purposes shall be provided with labeled fire exit hardware.

Exception : When acceptable to the Authority Having Jurisdiction, pairs of doors not provided with an astragal are permitted to have labeled fire exit hardware and an open back strike installed on the inactive leaf and either labeled fire exit hardware or any labeled latch capable of being operated by one obvious operation from the egress side installed on the active leaf.

(5) : Manually operated, labeled top and bottom flush bolts (FB1) or surface bolts (SB1) on the inactive leaf of a pair of doors shall be permitted when acceptable to the Authority Having Jurisdiction. This provision limits their use to rooms not normally occupied by humans (eg : transformer vaults, storage rooms). The inactive leaf does not require a closer.

## DUTCH HOLLOW METAL FIRE DOORS

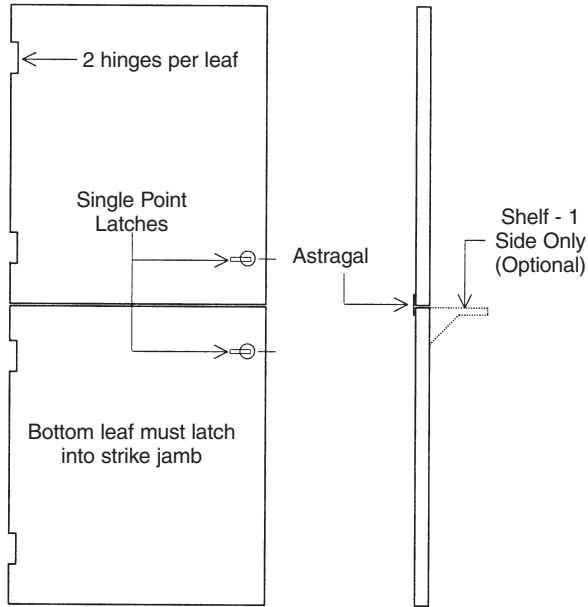

Top Leaf Latching into Strike Jamb

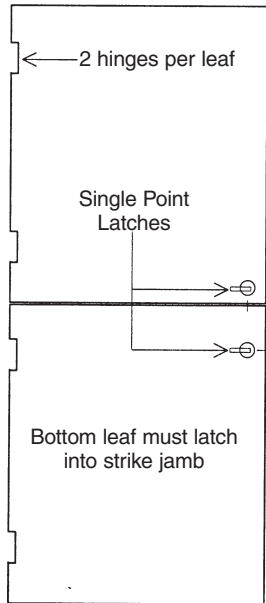

Top Leaf Latching into Bottom Leaf

### Product :

1-3/4" (44 mm) thick, single swing dutch door, with over-lapping astragal, with or without shelf, in ratings up to 3 hour fire protection.

### Maximum Door Opening :

4'0" x 8'0" (1219 x 2438 mm)

### Hardware :

Refer to Section 2, Page 2-5 for Hardware Code Summary

Hinges <sup>(1)</sup> :	H1 to H14
Offset Pivots :	Not Permitted
Locks, Latches, Deadbolts <sup>(2)</sup> :	L1 and L2
Latch Throw :	1/2"
Fire Exit Hardware :	Not Permitted
Overhead Closers :	C1 to C6, top leaf only
Floor Closer :	Not Permitted
Flush Bolts :	Not Permitted

### Glazing :

Consult individual member companies for requirements

### Frames :

Any fire-rated frame or transom frame shall be used.

### Specifications :

Refer to NAAMM/HMMA 860 or 861 for detailed specifications or consult individual member companies.

(1) : Mortise Self Closing Spring Hinges (H6) are limited to 3'0" x 7'0" (914 x 2134 mm) openings

(2) : Each leaf shall be provided with an active latch bolt. Only labeled locks and latches meeting both life safety and fire protection requirements shall be used. For doors other than those in a means of egress, deadbolts shall be permitted in addition to the active latch bolt or as otherwise permitted by the Authority Having Jurisdiction. See ANSI/NFPA 80.

## LOUVERED HOLLOW METAL FIRE DOORS

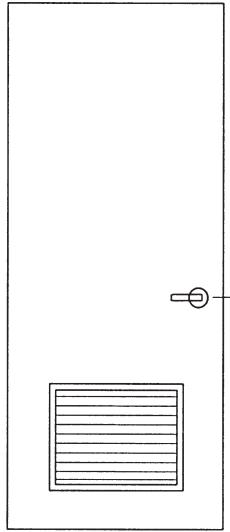

Singles

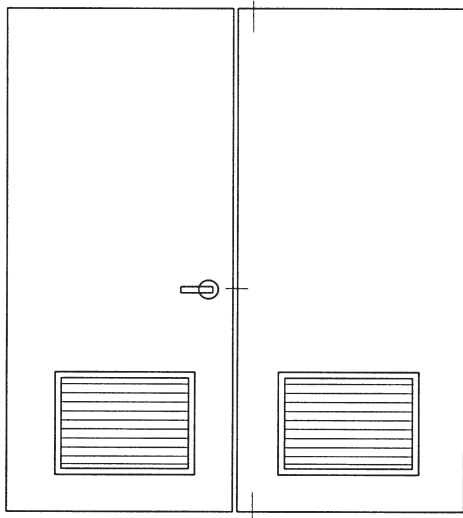

Pairs

### Product :

1-3/4" (44 mm) thick doors, swinging singly or in pairs, equipped with labeled fusible link, automatically closing fire door louvers, in ratings up to 1-1/2 hour fire protection. Louvers are not permitted in 1/3 hour or temperature rise rated fire doors, in fire doors in a "means of egress"<sup>(1)</sup> or in Factory Mutual labeled doors.

### Louvers :

Fire door louvers must have a fusible link system which automatically closes the louver blades when the link is activated. Maximum louver size : 24" x 24" (610 x 610 mm) per leaf. Louvers are permitted in lower portion of door only.

### Maximum Door Opening :

Singles : 4'0" x 10'0" (1219 x 3048 mm)

Pairs : 8'0" x 10'0" (2438 x 3048 mm)

Note : Where pairs are used for 1-1/2 hour or 3/4 hour applications, they may be installed without an over-lapping astragal.

### Maximum Leaf Size :

4'0" x 10'0" (1219 x 3048 mm)

### Hardware :

Refer to Section 2, Page 2-5 for Hardware Code Summary

Hinges <sup>(2)</sup> :	H1 to H14
Offset Pivots :	H15
Locks, Latches, Deadbolts <sup>(3)</sup> :	L1, L2 and L3
Latch Throw <sup>(4)</sup>	
- Singles : 8'0" ht and less:	1/2" (12.7 mm)
: over 8'0" ht:	3/4" (19 mm)
- Pairs :	3/4" (19 mm)
Fire Exit Hardware :	Not Permitted
Overhead Closers :	C1 to C6
Floor Closer :	C7 and C8
Flush Bolts <sup>(5)</sup> :	FB1 to FB4

### Glazing :

Not Permitted

### Frames :

Any fire-rated frame shall be used.

### Specifications :

Refer to NAAMM/HMMA 860 or 861 for detailed specifications or consult individual member companies.

(1) : See ANSI/NFPA 80

(2) : Mortise Self Closing Spring Hinges (H6) are limited to 3'0" x 7'0" (914 x 2134 mm) openings

(3) : All single doors and active leaf of pairs of doors shall be provided with an active latch bolt. Only labeled locks and latches meeting both life safety and fire protection requirements shall be used. Deadbolts shall be permitted in addition to the active latch bolt or as otherwise permitted by the Authority Having Jurisdiction. See ANSI/NFPA 80.

(4) : Latch throws shown are as per ANSI/NFPA 80. Some manufacturers are permitted to provide doors using smaller latch throws

(5) : Manually operated, labeled top and bottom flush bolts (FB1) or surface bolts (SB1) on the inactive leaf of a pair of doors shall be permitted when acceptable to the Authority Having Jurisdiction. This provision limits their use to rooms not normally occupied by humans (e.g. : transformer vaults, storage rooms). The inactive leaf does not require a closer.

# THREE SIDED FIRE DOOR FRAMES

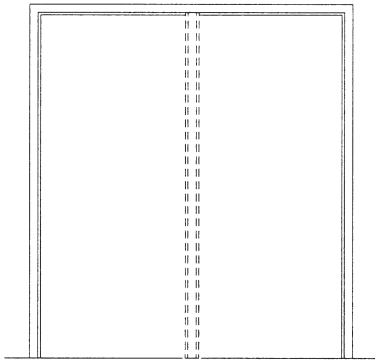
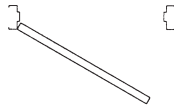
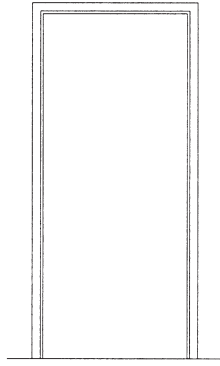

**Product :**

3 hour (maximum) fire door frames, used with fire doors swinging singly or in pairs.

**Maximum Door Opening :**

- Singles : 4'0" x 10'0" (1219 x 3048 mm)
- Pairs : 8'0" x 10'0" (2438 x 3048 mm)
- Contra-Swing<sup>(1)</sup> : 4'0" x 8'0" (1219 x 2438 mm)

**Maximum Leaf Size :**

- Singles and Pairs : 4'0" x 10'0" (1219 x 3048 mm)
- Contra-Swing : 4'0" x 8'0" (1219 x 2438 mm)

**Mullions :**

Mullions are optional and may be welded or removable, for either between or behind the door applications. Doors shall not be hinged off removable mullions.

**Anchors :**

Anchors are available for new or existing masonry, poured concrete, structural steel, wood and steel stud partitions. See "Anchors for Fire Rated Frame Product", Page 3-22 for additional information.

**Specifications :**

Frames shall be fabricated from hot rolled, cold rolled, galvanized, galvanized or stainless steel. Refer to NAAMM/HMMA 860, 861 or 866 for detailed specifications or consult individual member companies.

**Profiles :**

Single or double rabbet jambs, heads and mullions. See "Profiles for Fire-Rated Frame Product", Page 3-21 for additional information.

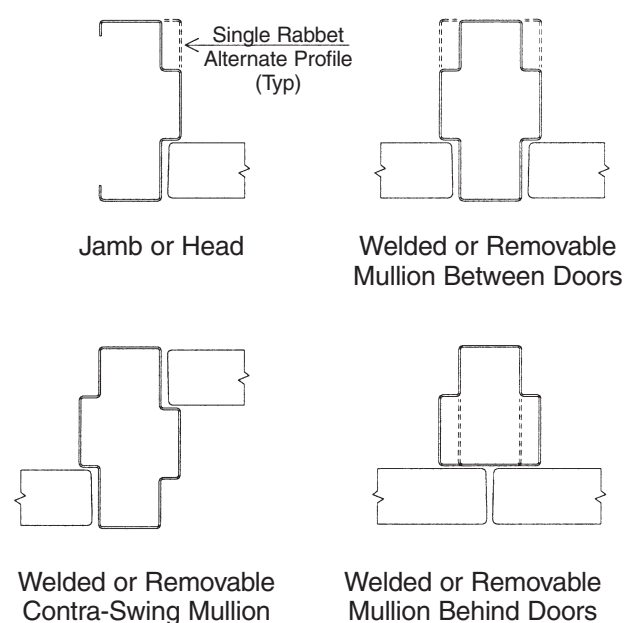
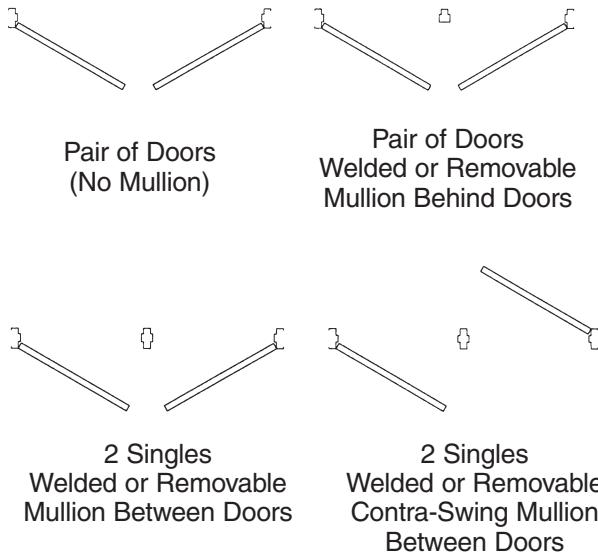

1) : Contra-Swing frames limited to 1-1/2 hour fire protection rating



## MULTIPLE OPENING FRAMES AND TRANSOM FRAMES

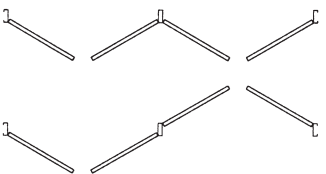
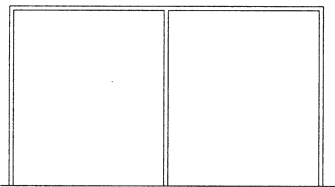
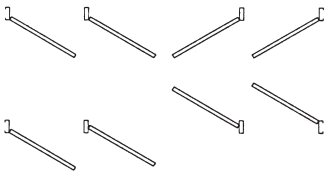
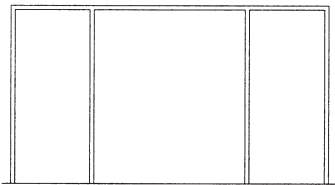
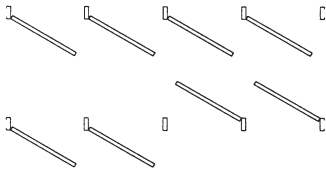
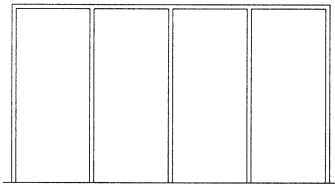
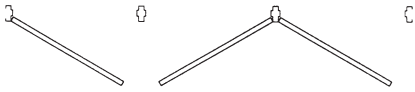
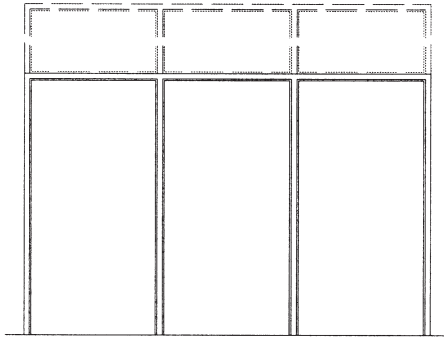

### Product :

1-1/2 hour (maximum) fire door frames and transom frames used with 1-3/4" (44 mm) thick fire doors, swinging in combinations of singles, pairs, contra-swing and/or double egress configurations

### Maximum Door Opening :

Singles : 4'0" x 8'0" (1219 x 2438 mm)

Pairs and Double Egress: 8'0" x 8'0" (2438 x 2438 mm)

### Maximum Leaf Size :

4'0" x 8'0" (1219 x 2438 mm)

### Maximum Over-All Unit Size :

12'8" width x 8'4" height (3861 x 2540 mm) frames

12'8" width x 10'0" height (3861 x 3048 mm) transom frames

### Mullions :

Vertical mullions at doors may be welded or removable for either between or behind the door applications. Doors shall not be hinged off removable mullions. Horizontal and vertical transom mullions must be welded.

### Transom Material :

Refer to Section 1, Table 5, Page 1-10 for requirements and options.

### Anchors :

Anchors are available for new or existing masonry, poured concrete, structural steel, wood and steel stud partitions. See "Anchors for Fire-Rated Frame Product", Page 3-22 for additional information.

### Specifications :

Frames shall be fabricated from hot rolled, cold rolled, galvanized, galvanized or stainless steel. Refer to NAAMM/HMMA 860, 861 or 866 for detailed specifications or consult individual member companies.

### Profiles :

Single or double rabbet jambs, heads and mullions. See "Profiles for Fire-Rated Frame Product", Page 3-21 for additional information.

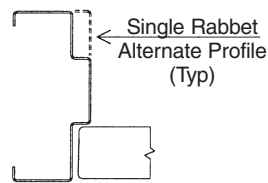

Jamb or Head

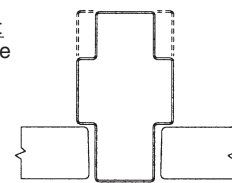

Welded or Removable Mullion Between Doors

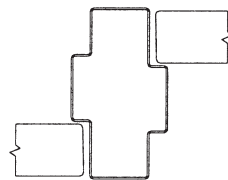

Welded or Removable Contra-Swing Mullion

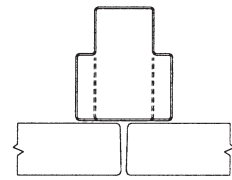

Welded or Removable Mullion Behind Doors

# FRAMES WITH 1-3/4" (44 mm) TRANSOM PANELS WITHOUT TRANSOM MULLION

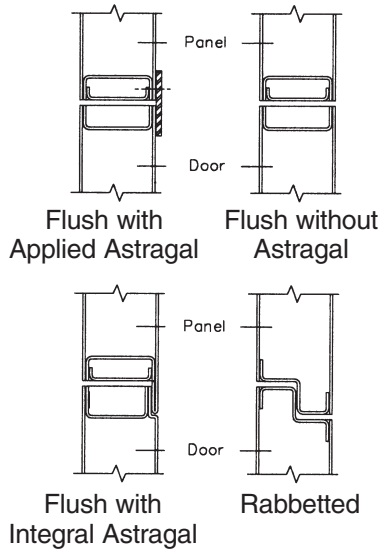
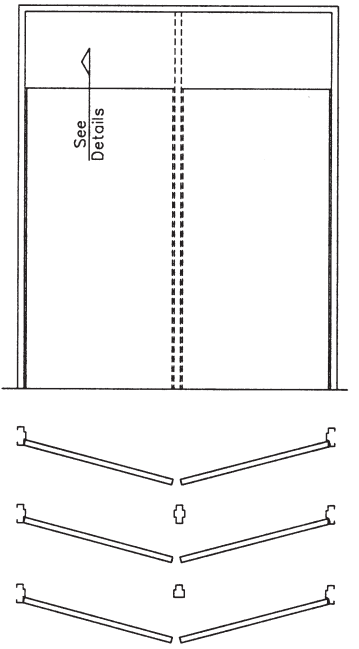
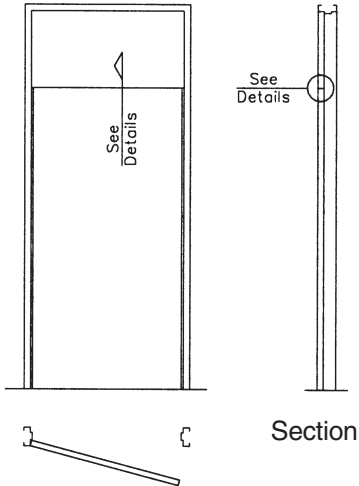

**Product :**  
 3 hour (maximum) fire door frame and 1-3/4" (44 mm) thick fixed or removable panel used with 1-3/4" (44 mm) thick fire doors swinging singly or in pairs.  
 Note : Flush panel may be provided without applied astragal in ratings up to 1-1/2 hour. For 3 hour rated flush panels an applied over-lapping or integral astragal is required.

**Maximum Door and Panel Opening :**  
 Singles : 4'0" x 11'4" (1219 x 3454 mm)  
 Pairs : 8'0" x 11'2" (2438 x 3404 mm)

**Maximum Leaf Size :**  
 4'0" x 9'0" (1219 x 2743 mm)

**Maximum Panel Size :**  
 Singles : 4'0" x 4'6" (1219 x 1372 mm)  
 Pairs : 8'0" x 4'0" (2438 x 1219 mm)

Note : The most common application for this type of frame utilizes a head above the panel. However, frames are available where the jambs are terminated at the top of the panel and a head is not required.

**Vertical Mullions :**  
 Welded vertical mullions at doors for between or behind the door applications are permitted.

**Anchors :**  
 Anchors are available for new or existing masonry, poured concrete, structural steel, wood and steel studs partitions. See "Anchors for Fire-Rated Frame Product", Page 3-22 for additional information

**Hardware :**  
 Flush bolts (FB2 to FB4) required on inactive leaf of pairs. Fire exit devices are approved for use with transom panels.

**Specifications :**  
 Frame and panel shall be fabricated from hot rolled, cold rolled, galvanized or galvanized steel. For all other design and construction requirements consult individual member companies.

**Profiles :**  
 Single or double rabbet jambs, heads and vertical mullions. See "Profiles for Fire-Rated Frame Product", Page 3-21 for additional information.

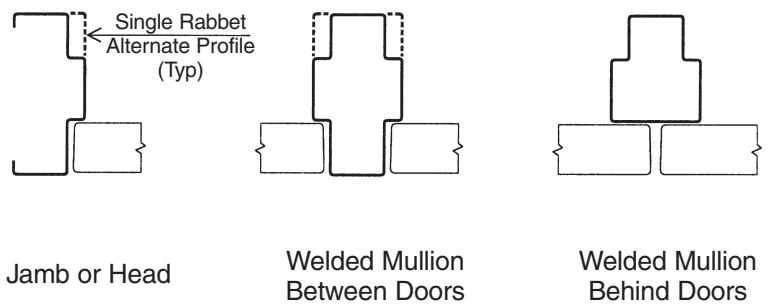

# TRANSOM FRAMES WITH 1-3/4" (44 mm) TRANSOM PANELS AND TRANSOM MULLION

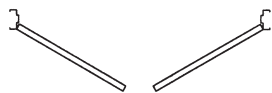
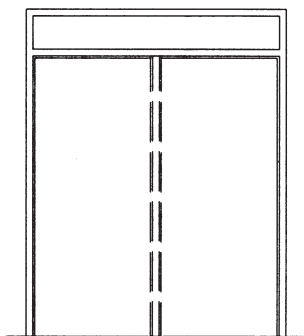
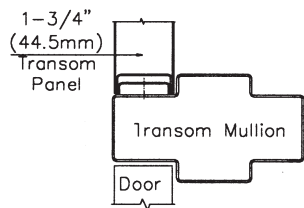
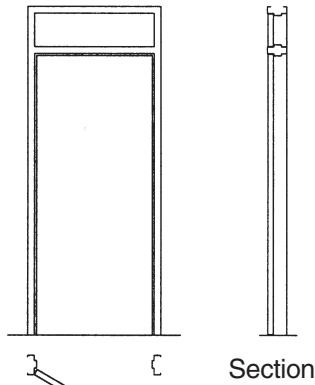

Pair of Doors  
(No Vertical Mullion)

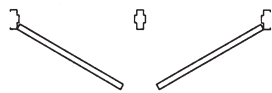

2 Singles  
Welded or Removable Mullion  
Between Doors

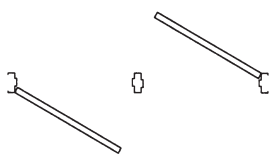

2 Singles  
Welded or Removable  
Contra-Swing Mullion  
Between Doors

## Product :

3 hour (maximum) fire door transom frames with 1-3/4" (44 mm) thick transom panels used with 1-3/4" (44 mm) thick fire doors swinging singly or in pairs.

## Door/Transom Opening :

Singles : 4'0" x 11' 10" (1219 x 3607 mm)  
Pairs : 8'0" x 11' 10" (2438 x 3607 mm)

## Maximum Leaf Size :

Singles and Pairs : 4'0" x 10'0" (1219 x 3048 mm)  
Contra-Swing<sup>(1)</sup> : 4'0" x 8'0" (1219 x 2438 mm)

## Maximum Transom Panel Size :

Singles : 4'0" x 4'0" (1219 x 1219 mm)  
Pairs : 8'0" x 4'0" (2438 x 1219 mm)

## Transom Material :

Transom panels shall be fabricated from hot rolled, cold rolled, galvanized, galvannealed or Type 430 stainless steel.

## Mullions :

Vertical mullions for between the door applications are optional and may be welded or removable. Doors shall not be hinged off removable mullions. Horizontal transom mullion can be welded or removable.

## Anchors :

Anchors are available for new or existing masonry, poured concrete, structural steel, wood and steel stud partitions. See "Anchors for Fire-Rated Frame Product", Page 3-22 for additional information.

## Specifications :

Transom frames shall be fabricated from hot rolled, cold rolled, galvanized, galvannealed or stainless steel. Refer to NAAMM/HMMA 860, 861 or 866 for detailed specifications or consult individual member companies.

## Profiles :

Single or double rabbet jambs, heads and mullions. See "Profiles for Fire-Rated Frame Product", Page 3-21 for additional information.

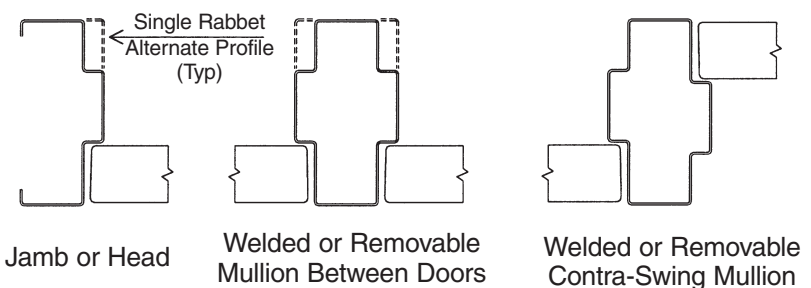

(1) : Contra-Swing frames limited to 1-1/2 hour fire protection rating

## TRANSOM FRAMES WITH TRANSOM PANELS AND TRANSOM MULLIONS

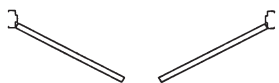
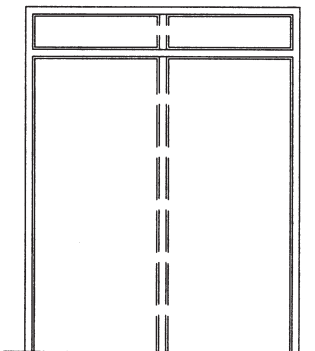
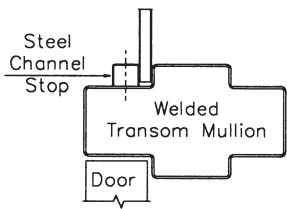
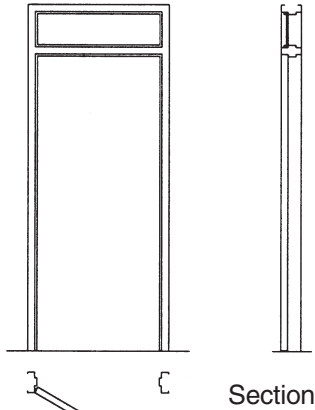

Pair of Doors  
(No Vertical Mullion)

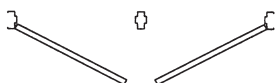

2 Singles  
Welded or Removable Mullion  
Between Doors

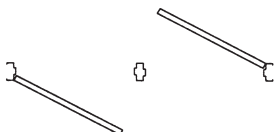

2 Singles  
Welded or Removable  
Contra-Swing Mullion  
Between Doors

### Product :

3 hour (maximum) fire door transom frames with steel-faced 3/8" to 3/4" (9.5 to 19.1 mm) thick transom panels used with 1-3/4" (44 mm) thick fire doors swinging singly, in pairs, contra-swing or double egress configurations.

### Maximum Door/Transom Opening :

Singles : 4'0" x 12'0" (1219 x 3658 mm)

Pairs : 8'0" x 12'0" (2438 x 3658 mm)

### Maximum Leaf Size :

Singles, Pairs and Double Egress : 4'0" x 10'0" (1219 x 3048 mm)

Contra-Swing<sup>(1)</sup> : 4'0" x 8'0" (1219 x 2438 mm)

### Maximum Transom Panel Size :

Singles : 4'0" x 4'0" (1219 x 1219 mm)

Pairs, Double Egress

and Contra-Swing : 8'0" x 4'0" (2438 x 1219 mm)

### Transom Material :

Minimum 0.032" (0.8 mm) thick hot rolled, cold rolled, galvanized, galvanized or Type 430 stainless steel laminated to each face of an approved core. For size and label restrictions refer to Section 1, Table 5, Page 1-10 for requirements and options.

### Mullions :

Vertical mullions for between the door applications are optional and may be welded or removable. Doors shall not be hinged off removable mullions. Horizontal and vertical transom mullions must be welded.

### Anchors :

Anchors are available for new or existing masonry, poured concrete, structural steel, wood and steel stud partitions. See "Anchors for Fire-Rated Frame Product", Page 3-22 for additional information.

### Specifications :

Transom frames shall be fabricated from hot rolled, cold rolled, galvanized, galvanized or stainless steel. Refer to NAAMM/HMMA 860, 861 or 866 for detailed specifications or consult individual member companies

### Profiles :

Single or double rabbet jambs, heads and mullions. See "Profiles for Fire-Rated Frame Product", Page 3-21 for additional information.

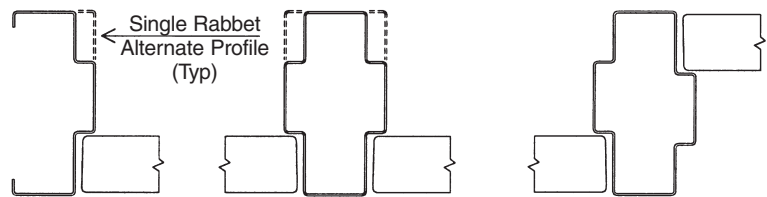

Jamb or Head

Welded or Removable  
Mullion Between Doors

Welded or Removable  
Contra-Swing Mullion

1) : Contra-Swing frames limited to 1-1/2 hour fire protection rating

## TRANSOM FRAMES - GLAZED

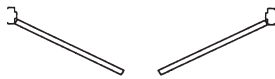
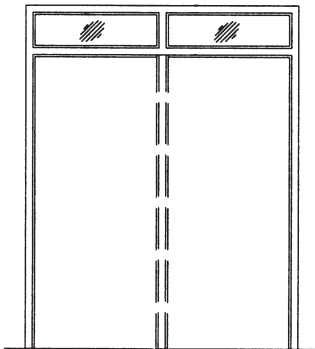
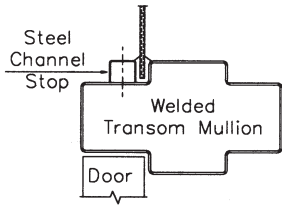
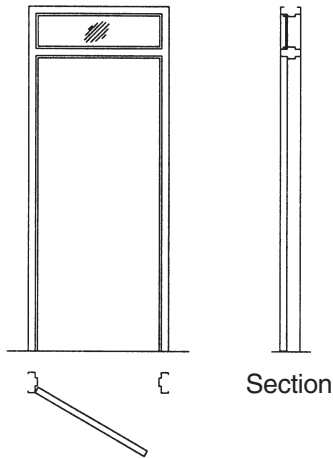

Pair of Doors  
(No Vertical Mullion)

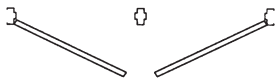

2 Singles  
Welded or Removable Mullion  
Between Doors

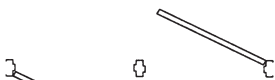

2 Singles  
Welded or Removable  
Contra-Swing Mullion  
Between Doors

### Product :

Fire door transom frames for labeled glazing materials used with 1-3/4" (44 mm) thick fire doors swinging singly, in pairs, contra-swing or double egress configurations. Transoms with labeled wired glazing provide up to a 3/4 hour fire rating. With some labeled laminated or non-wired glazing materials, transoms are available up to 1-1/2 hour fire protection rating. Refer to glazing manufacturers listings for additional information.

### Maximum Door/Transom Opening :

Drywall Partitions:

- Singles : 4'0" x 11'4" (1219 x 3454 mm)

- Pairs : 8'0" x 11'4" (2438 x 3454 mm)

All Other Partitions:

- Singles : 4'0" x 12'0" (1219 x 3658 mm)

- Pairs : 8'0" x 12'0" (2438 x 3658 mm)

### Maximum Leaf Size :

4'0" x 10'0" (1219 x 3048 mm)

### Maximum Individual Transom Light Size :

Refer to Section 1, Table 5, Page 1-10 for requirements and options

### Glazing :

Refer to Section 1, Table 5, Page 1-10 for requirements and options

### Mullions :

Vertical mullions for between the door applications are optional and may be welded or removable. Doors shall not be hinged off removable mullions. Horizontal and vertical transom mullions must be welded.

### Anchors :

Anchors are available for new or existing masonry, poured concrete, structural steel, wood and steel stud partitions. See "Anchors for Fire-Rated Frame Product", Page 3-22 for additional information.

### Specifications :

Transom frames shall be fabricated from hot rolled, cold rolled, galvanized, galvanized or stainless steel. Refer to NAAMM/HMMA 860, 861 or 866 for detailed specifications or consult individual member companies

### Profiles :

Single or double rabbet jambs, heads and mullions. See "Profiles for Fire-Rated Frame Product", Page 3-21 for additional information.

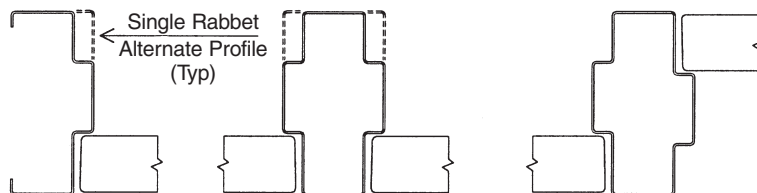

Jamb or Head

Welded or Removable  
Mullion Between Doors

Welded or Removable  
Contra-Swing Mullion

## SIDELIGHT FRAMES - GLAZED OR PANELED

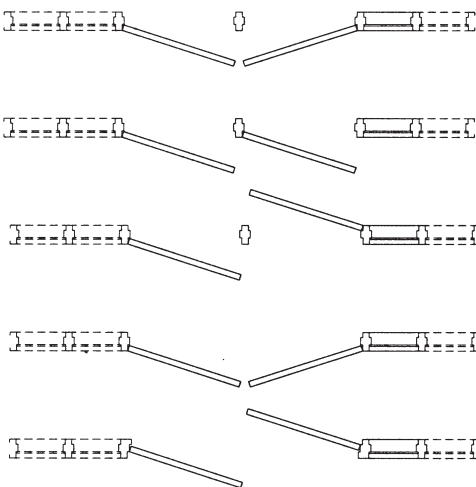
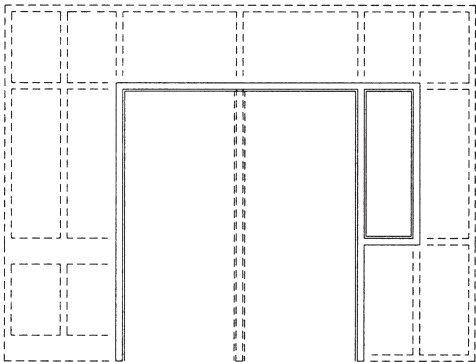
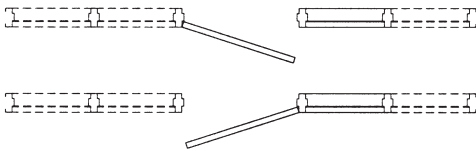
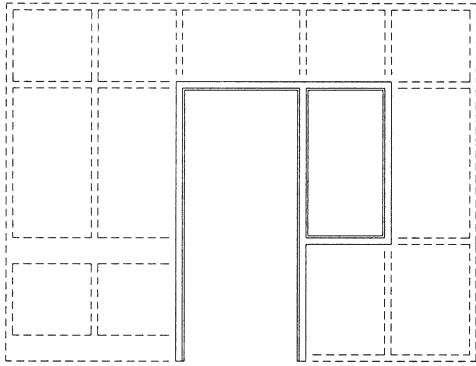

### Product :

Fire door frame with side panels or lights and optional transom panels or lights, used with 1-3/4" (44 mm) thick fire doors swinging singly, in pairs, contra-swing or double egress configurations. Sidelights with labeled wired glazing provide up to a 3/4 hour fire protection rating. With some labeled laminated or non-wired glazing materials, sidelights are available up to 1-1/2 hour fire protection rating. Refer to glazing manufacturers listings for additional information. Sidelight frames incorporating only solid panels are available up to 1-1/2 hour fire protection rating.

### Maximum Over-All Unit Size :

Drywall Partitions : 12'10" x 11'4" (3912 x 3454 mm)  
All Other Partitions : 13'6" x 12'0" (4115 x 3658mm)

### Maximum Door Opening :

Singles : 4'0" x 10'0" (1219 x 3048 mm)  
Pairs : 8'0" x 10'0" (2438 x 3048 mm)

### Maximum Leaf Size :

4'0" x 10'0" (1219 x 3048 mm)

### Maximum Individual Panel Size :

Transom : 96" x 48" (2438 x 1219 mm)  
Side : 36" x 54" (914 x 1372 mm)

### Maximum Individual Side or Transom Light Size :

Refer to Section 1, Table 5, Page 1-10 for requirements and options.

### Glazing :

Refer to Section 1, Table 5, Page 1-10 for requirements and options.

### Panel Material :

Minimum 0.032" (0.8 mm) thick hot rolled, cold rolled, galvanized, galvanized or Type 430 stainless steel laminated to each face of an approved core. For size and label restrictions refer to Section 1, Table 5, Page 1-10 for requirements.

### Mullions :

Vertical mullions for between the door applications are optional and may be welded or removable. All other mullions shall be welded. Doors shall not be hinged off removable mullions.

### Anchors :

Anchors are available for new or existing masonry, poured concrete, structural steel, wood and steel stud partitions. See "Anchors for Fire-Rated Frame Product", Page 3-22 for additional information.

### Specifications :

Sidelight frames shall be fabricated from hot rolled, cold rolled, galvanized, galvanized or stainless steel. Refer to NAAMM/HMMA 860, 861 or 866 for detailed specifications or consult individual member companies.

### Profiles :

Single or double rabbet jambs, heads, mullions and sills. Mullions (not surrounding doors) and sills, may be recessed from perimeter members. See "Profiles for Fire-Rated Frame Product", Page 3-21 for additional information.

## WINDOW FRAMES - GLAZED OR PANELED

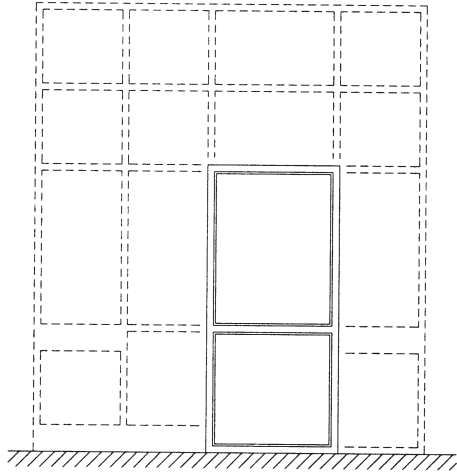

Floor Mounted Fire Window

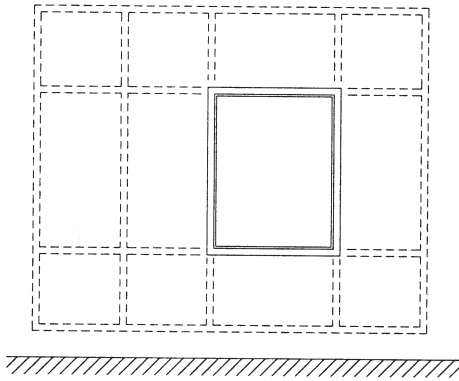

Knee Wall Mounted Fire Window

### Product :

Fire window frames with fixed openings and labeled glazing materials or panels. Windows with labeled wired glazing provide up to a 3/4 hour fire protection rating. With some labeled laminated and non-wired glazing materials, windows are available up to 1-1/2 hour fire protection rating. Refer to glazing manufacturers listings for additional information. Fire windows may be mounted directly on the floor or on knee wall partitions.

### Maximum Over-All Unit Size :

Drywall Partitions : 12'10" x 11'4" (3912 x 3454 mm)  
All Other Partitions : 13'6" x 12'0" (4115 x 3658 mm)

### Maximum Individual Light Size :

Refer to Section 1, Table 5, Page 1-10 for requirements and options

### Glazing :

Refer to Section 1, Table 5, Page 1-10 for requirements and options

### Panel Material :

Minimum 0.032" (0.8 mm) thick hot rolled, cold rolled, galvanized, galvanized or Type 430 stainless steel laminated to each face of an approved core. For size and label restrictions refer to Section 1, Table 5, Page 1-10 for requirements.

### Anchors :

Anchors are available for new or existing masonry, poured concrete, structural steel, wood and steel stud partitions. See "Anchors for Fire-Rated Frame Product", Page 3-22 for additional information.

### Specifications :

Window frames shall be fabricated from hot rolled, cold rolled, galvanized, galvanized or stainless steel. Refer to NAAMM/HMMA 860, 861 or 866 for detailed specifications or consult individual member companies.

### Profiles :

Single or double rabbet jambs, heads, mullions and sills. Mullions and sills may be recessed from perimeter members. See "Profiles for Fire-Rated Frame Product", Page 3-21 for additional information.

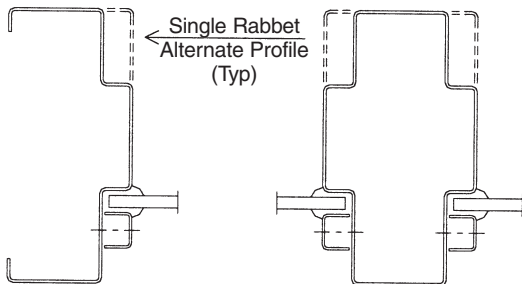

Jamb or Head

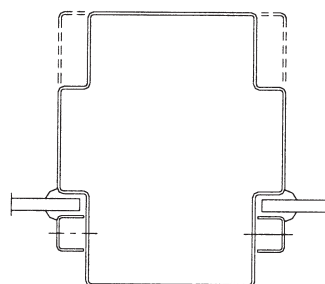

Mullions

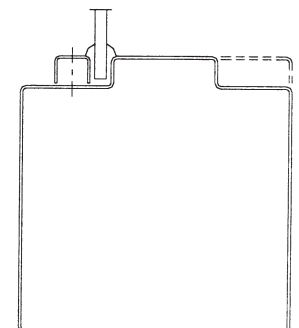

Sill

# SOUND CONTROL HOLLOW METAL DOOR AND FRAME ASSEMBLIES

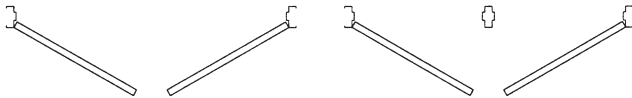
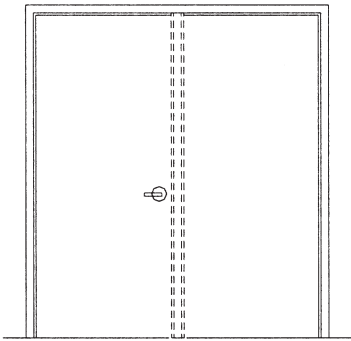
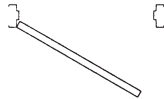
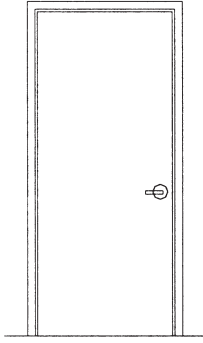

Pair of Doors  
(No Vertical Mullion)

2 Singles  
Welded Mullion  
Between Doors

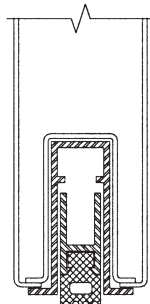

Door Bottom Details  
(Varies with manufacturer)

## Product :

3 hour (maximum) sound control fire door and frame assembly with 1-3/4" (44 mm) (minimum) thick doors, swinging singly or in pairs. Doors, frame and sound seals must be provided as a complete assembly.

## Maximum Door Opening :

Singles : 4'0" x 8'0" (1219 x 2438 mm)  
Pairs : 8'0" x 8'0" (2438 x 2438 mm)

## Maximum Leaf Size :

4'0" x 8'0" (1219 x 2438 mm)

## Glazing :

3 hour - glazing not permitted (STC\* 52 maximum)  
1 1/2 hour - 100 in<sup>2</sup> (0.065m<sup>2</sup>) glass light per leaf  
(STC 48 maximum)  
3/4 hour - 300 in<sup>2</sup> (0.194m<sup>2</sup>) glass light per leaf  
(STC 47 maximum)

\* : STC - Sound Transmission Class : Air borne sound transmission loss is measured in accordance with ASTM E90 and the STC is determined by the procedures set forth in ASTM E413

## Mullions :

Welded mullions for between the door applications are optional.

## Anchors :

Anchors are available for new or existing masonry, poured concrete, structural steel, wood and steel stud partitions. See "Anchors for Fire-Rated Frame Product", Page 3-22 for additional information.

## Specifications :

Assemblies shall be fabricated from hot rolled, cold rolled, galvanized or galvanized steel. Refer to NAAMM/HMMA 865 for detailed specifications or consult individual member companies.

## Profiles :

Cased open, single or double rabbet jambs, heads and mullions with applied adjustable gasketing.

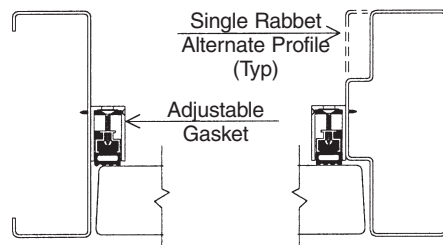

Jamb or Head  
(Gasket varies  
with manufacturer)



# DETENTION SECURITY HOLLOW METAL DOOR AND FRAME ASSEMBLIES

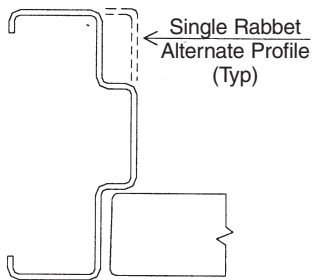
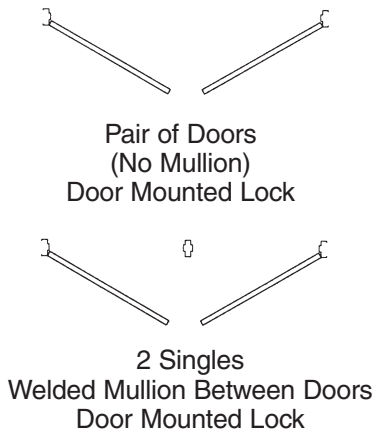
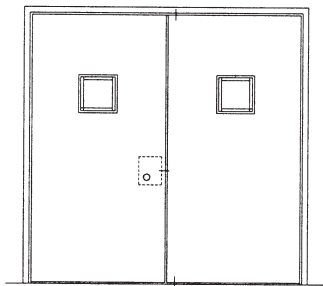
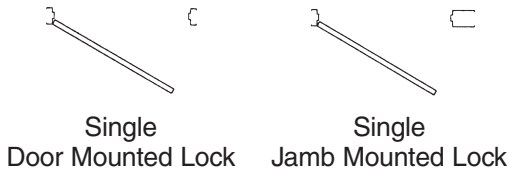
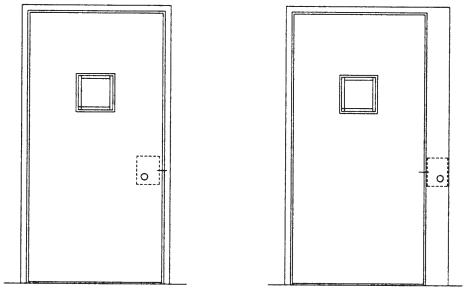

Door Mounted Lock  
Strike Jamb, Hinge  
Jamb Head

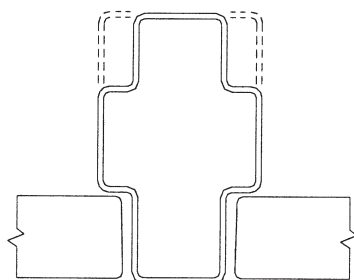

Welded Mullion  
Between Doors

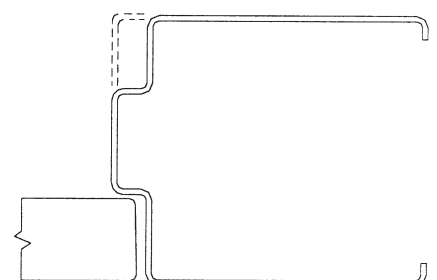

Jamb Mounted Lock  
Strike Jamb

## Product :

3 hour (maximum) detention security fire door and frame assembly swinging singly or in pairs or sliding singly, for use in detention and correctional facilities and other buildings where a high degree of security is required. Detention security assemblies must comply with ASTM F1450 test procedures and acceptance criteria of HMMA 863 for impact resistance, static load, rack, edge crush and removable glazing stop requirements. In addition these products are available with bullet-resistant capabilities meeting ANSI/UL 752.

## Maximum Door Opening :

Singles : 4'0" x 8'0" (1219 x 2438 mm)  
 Pairs : 8'0" x 8'0" (2438x 2438 mm)  
 Sliding : 4'0" x 8'0" (1219 x 2438 mm)

## Maximum Leaf Size :

4'0" x 8'0" (1219 x 2438 mm)

## Glazing :

Refer to Section 1, Table 4, Page 1-9 for door requirements and options

## Mullions :

Welded mullions for between the door applications are optional.

## Anchors :

Anchors are available for new or existing masonry or poured concrete partitions. See "Anchors for Fire-Rated Frame Product", Page 3-22 for additional information

## Specifications :

Assemblies shall be fabricated from hot rolled, cold rolled, galvanized or galvanized steel. Refer to NAAMM/HMMA 863 for detailed specifications or consult individual member companies.

## Profiles :

Single and double rabbet jambs, heads and mullions. See "Profiles for Fire-Rated Frame Product", Page 3-21 for additional information.

# BULLET-RESISTANT HOLLOW METAL DOOR AND FRAME ASSEMBLIES

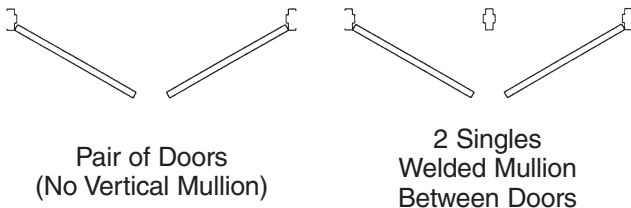
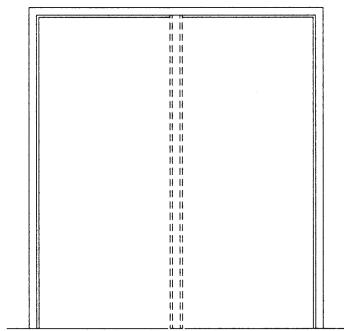
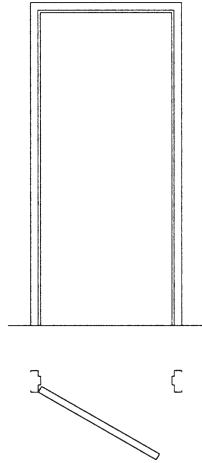

Pair of Doors  
(No Vertical Mullion)

2 Singles  
Welded Mullion  
Between Doors

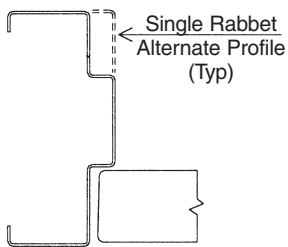

Jamb or Head

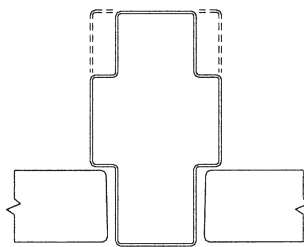

Mullion

## Product :

3 hour (maximum) bullet-resistant fire door and frame assembly swinging singly or in pairs, intended to form bullet-resistant barriers which protect against robbery or holdup.

These are specialized door and frame assemblies providing protection from medium (9 mm) through super power (.44 Magnum) hand guns, high power (30-06) rifles, military munitions (308 Winchester rifle) or multiple shots from submachine guns (9mm Uzi) up to military assault rifles (M-14). These assemblies have been tested to the requirements of ANSI/UL 752, "Bullet-Resisting Equipment".

There are 8 rating levels with Level 1 for medium power hand guns up to Level 8 for M-14 assault rifles. A supplementary category for 12 gage shot guns with rifled lead slug and 00 lead buckshot is also available. Assemblies meeting the additional shot gun requirements have a suffix "SG" added to the rating designation.

## Maximum Door Opening :

Singles : 4'0" x 10'0" (1219 x 3048 mm)  
Pairs : 8'0" x 10'0" (2438 x 3048 mm)

## Maximum Leaf Size :

4'0" x 10'0" (1219 x 3048 mm)

## Glazing :

Consult individual member companies for details

## Mullions :

Welded mullions for between the door applications are optional

## Anchors :

Anchors are available for new or existing masonry, poured concrete, structural steel, wood and steel stud partitions. See "Anchors for Fire-Rated Frame Product", Page 3-22 for additional information.

## Specifications :

Assemblies shall be fabricated from hot rolled, cold rolled, galvanized or galvanealed steel. For all other design and construction features consult individual member companies.

## Profiles :

Single and double rabbet jambs, heads and mullions. See "Profiles for Fire-Rated Frame Product", Page 3-21 for additional information.

# RADIATION SHIELDING HOLLOW METAL DOOR AND FRAME ASSEMBLIES

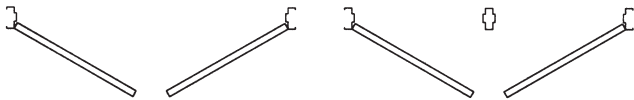
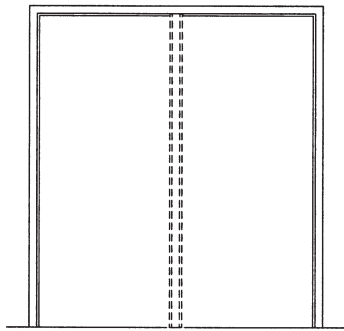
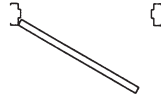
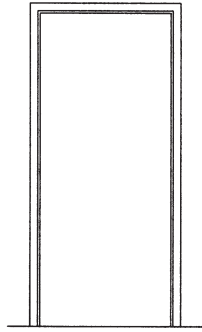

Pair of Doors  
(No Vertical Mullion)

2 Singles  
Welded Mullion  
Between Doors

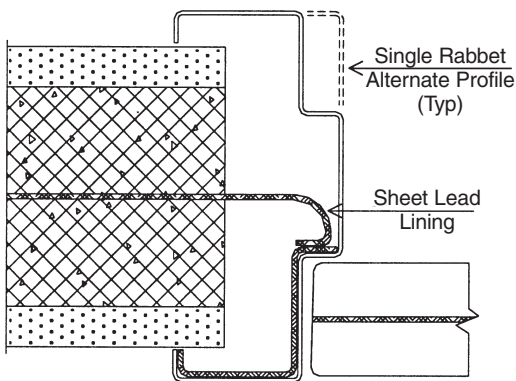

Jamb or Head

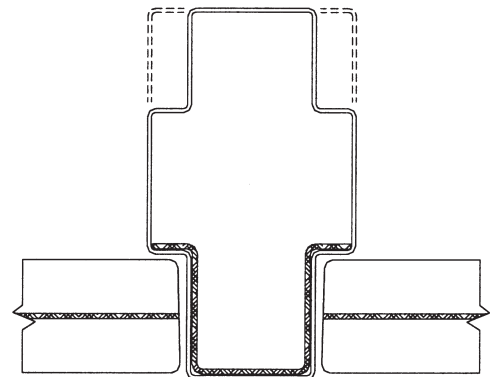

Mullion

## Product :

3 hour (maximum) radiation shielding door and frame assembly with 1-3/4" (44 mm) thick doors swinging singly or in pairs used to provide shielding against x-rays and other forms of radiation which could be injurious to humans, other forms of life or material.

These assemblies are designed to specification to provide shielding against specific types and intensities of radiation.

## Maximum Door Opening :

Singles : 4'0" x 8'0" (1219 x 2438 mm)

Pairs : 8'0" x 8'0" (2438 x 2438 mm)

## Maximum Leaf Size :

4'0" x 8'0" (1219 x 2438 mm)

## Glazing :

Refer to Section 1, Table 4, Page 1-9 for requirements

## Mullions :

Welded mullions for between the door applications are optional.

## Anchors :

Anchors are available for new or existing masonry, poured concrete, structural steel, wood and steel stud partitions. See "Anchors for Fire-Rated Frame Product", Page 3-22 for additional information

## Specifications :

Assemblies shall be fabricated from hot rolled, cold rolled, galvanized or galvanized steel. For all other design and construction features consult individual member companies.

## Profiles :

Single or double rabbet jambs, heads and mullions. See "Profiles for Fire-Rated Frame Product", Page 3-21 for additional information.

## PROFILES FOR FIRE-RATED FRAME PRODUCT

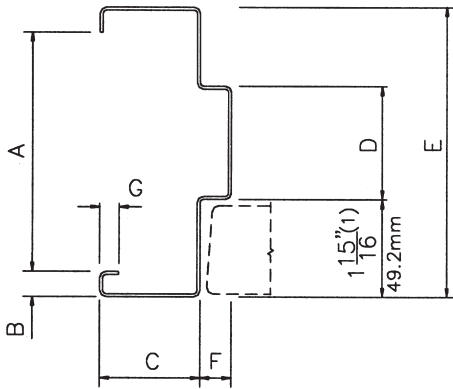

Double Rabbet Jamb, Heads and Sills						
A	B	C	D	E	F	G
Throat	Return	Face	Soffit	Jamb Depth	Stop	Drywall Return
2-1/4" <sup>(3)</sup>		1" <sup>(2)</sup>	3/16"	2-3/8"	5/8"	1/4"
Min	0					
57.1 mm <sup>(3)</sup>		25.4 mm	4.8 mm	60.3 mm	15.9 mm	6.4 mm
Max	3/4"	12"	-	14-1/2"	-	3/4"
330.2 mm	19.1 mm	304.8 mm		368.3 mm		19.1 mm

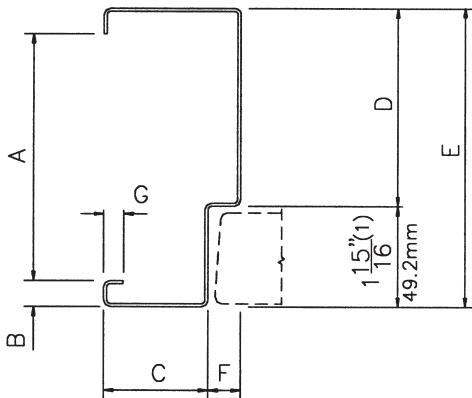

Single Rabbet Jamb, Heads and Sills						
A	B	C	D	E	F	G
Throat	Return	Face	Soffit	Jamb Depth	Stop	Drywall Return
2" <sup>(3)</sup>		1" <sup>(2)</sup>	3/16"	2-1/8"	5/8"	1/4"
Min	0					
50.8 mm <sup>(3)</sup>		25.4 mm	4.8 mm	60 mm	15.9 mm	6.4 mm
Max	3/4"	12"	-	14-1/2"	-	3/4"
330.2 mm	19.1 mm	304.8 mm		368.3 mm		19.1 mm

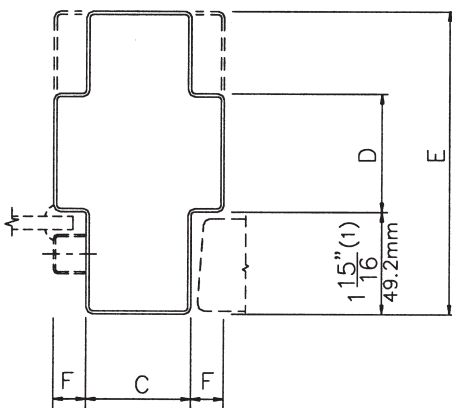

Single or Double Rabbet Mullions				
	C	D	E	F
	Face	Soffit	Jamb Depth	Stop
Min	0			
	1" <sup>(2)</sup>	1"	4-1/2"	5/8"
	25.4 mm	25.4 mm	114.3 mm	15.9 mm
Max				
	12"	-	10-1/2"	-
	304.8 mm		266.7 mm	

(1) : To suit 1-3/4" (44 mm) doors

(2) : For 3 sided frames in masonry or concrete partitions and surrounding glazed openings in sidelight or window frames. 1-1/4" (31.8 mm) minimum at all frames in stud walls, all transom frames and surrounding door openings in sidelight frames.

(3) : Larger dimensions may be required to suit specific wall types

### Wall Anchors - General :

## ANCHORS FOR FIRE-RATED FRAME PRODUCT

Each jamb of the door frame shall be provided with anchors to fit the wall construction to which the jamb is to be fastened. Each anchor shall be located immediately above or below the hinge reinforcing on the hinge jamb and directly opposite on the strike jamb as shown in Figure 2. Fire-rated frames require two anchors for each jamb up to 5'0" (1524 mm) and an additional anchor for each additional 2'6" (762 mm) of height or fraction thereof.

For openings in stud partitions HMMA recommends that one additional anchor be provided for each jamb over the number of anchors required for masonry openings of equivalent height.

Approved anchors, similar to those shown on these pages or non-welded, snap-in or friction fit as shown in HMMA 860, must be used with fire-rated frame product.

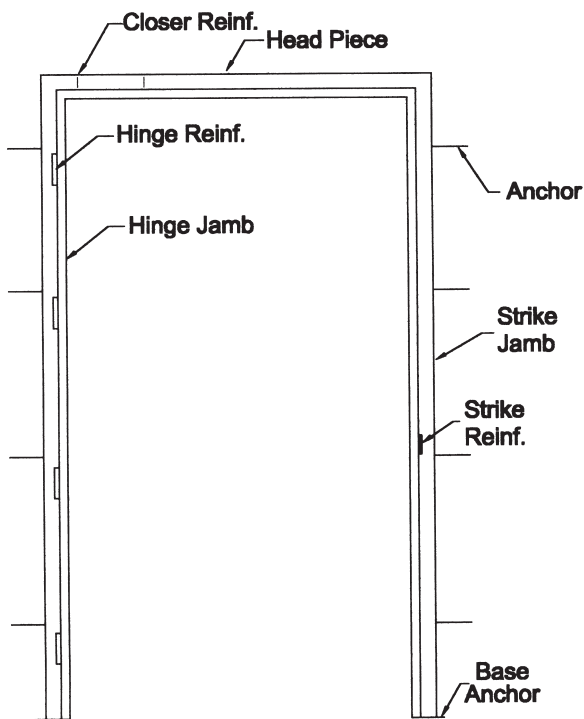

FIGURE 2  
SINGLE UNIT TYPE PRESSED STEEL FRAME

### Masonry Anchors :

Figures 3A, 3B and 3C illustrate masonry anchors approved for fire-rated frames. The adjustable strap-and-stirrup type is recommended for hollow metal frames. The stirrup or "yoke" is welded to the back of the jamb soffit. This type of anchor can be used in either masonry or poured concrete construction and provides sufficient adjustment for masonry coursing as well as access for full grouting of jamps.

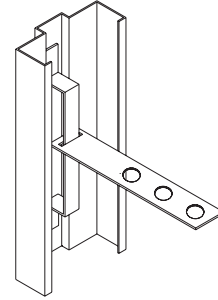

FIGURE 3A  
STRAP AND STIRRUP ANCHOR

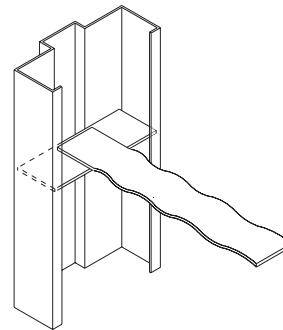

FIGURE 3B  
T-STRAP ANCHOR

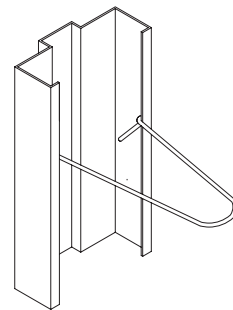

FIGURE 3C  
WIRE LOOP ANCHOR

**Steel Stud Anchors :**

Figure 4 illustrates a steel stud anchor which is welded to the back of the jamb and attached to the steel stud by welding or mechanical fasteners.

An alternate anchorage method, similar to that shown in Figure 6, where jamb and head soffits are pierced and dimpled for 1/4" (6mm) diameter sheet metal screws not more than 6" (152 mm) from each end and at 24" (610 mm) OC maximum, is also permitted.

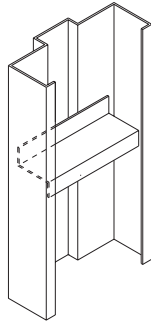

FIGURE 4  
STEEL STUD ANCHORS

**Expansion-Shell Anchors :**

Figure 6 illustrates an existing masonry or concrete anchor. The frame is anchored in prepared openings by means of flat head bolts and expansion shells. Anchors of this type are located not more than 6 inches (152 mm) from the top and bottom of each jamb with intermediate anchors spaced at a maximum of 26 inches (660 mm) on center.

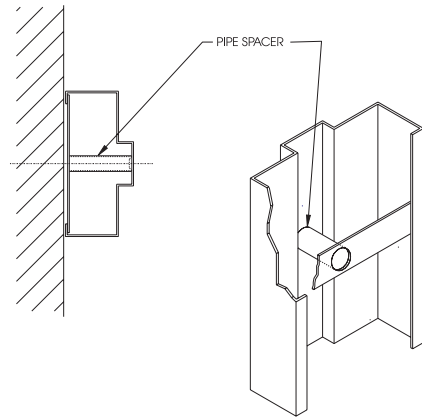

FIGURE 6  
EXPANSION BOLT ANCHOR

**Wood Stud Anchors :**

Figures 5A and 5B illustrate wood stud anchors which are welded to the back of the jamb and attached to the wood studs with fasteners through holes in the anchor.

The anchor method illustrated in Figure 6 can also be used for wood stud partitions. Wood screws replace the sheet metal screws.

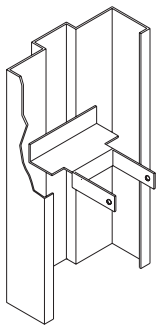

FIGURE 5A  
WOOD STUD  
ANCHOR  
Z ANCHOR

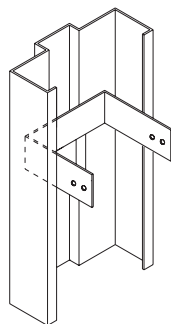

FIGURE 5B  
WOOD STUD

**Floor Anchors :**

Figure 7A illustrates a welded floor anchor and Figure 7B shows an adjustable type floor anchor. These anchors must be welded to the inside face of each frame. Floor anchors are not required for two-section type frames with a pressed-steel rough buck, nor are they required for frames provided with expansion-shell anchors.

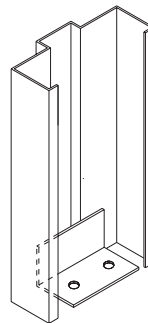

FIGURE 7A  
WELDED FLOOR  
ANCHOR

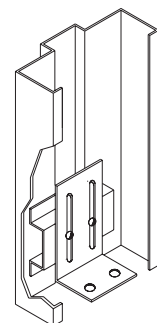

FIGURE 7B  
ADJUSTABLE  
FLOOR ANCHOR

## SUMMARY - HOLLOW METAL FIRE DOORS

Door Description	Maximum Fire Rating (Hours) <sup>(1)</sup>	Maximum Door Opening	Swinging Singly Swinging in Pairs	Face Sheets	Single Door or Active Leaf of Pair	Inactive Leaf of Pair or 2nd Leaf of 2 Singles	With Over-Lapping Astragal Without Over-Lapping Astragal
				0.093" (2.3 mm, 12 ga) 0.067" (1.7 mm, 14 ga) 0.053" (1.3 mm, 16 ga) 0.042" (1.0 mm, 18 ga)	Lock or Latch <sup>(2)</sup> Mortise Fire Exit Hardware Rim Fire Exit Hardware <sup>(3)</sup> Vertical Rod Fire Exit Hardware	Lock or Latch <sup>(2)</sup> Mortise Fire Exit Hardware <sup>(4)</sup> Rim Fire Exit Hardware <sup>(3)</sup> Vertical Rod Fire Exit Hardware Open Back Strike Flush Bolts	
Basic Fire Door <sup>(6,7)</sup>	3	4' x 9' 4' x 10' 2 @ 4' x 10' 2 @ 4' x 10' 8' x 10' 8' x 10'	• • • • • •	• • • • • •	• • • • • •	• • • • • •	• • • • • •
	1 1/2	8' x 10'	•	•	•	•	•
Pairs in a Means of Egress <sup>(6,7)</sup>	3 <sup>(5)</sup>	8' x 10'	•	•	•	•	•
	1 1/2	8' x 10' 8' x 10'	• •	• •	• •	• •	• •
Temperature Rise Rated Door <sup>(7)</sup> (250°F at 30 Minutes Maximum)	3	4' x 8'	•	•	•	•	•
	1 1/2	4' x 10' 8' x 10' 8' x 10' 8' x 10'	• • • •	• • • •	• • • •	• • • •	• • • •
Double Egress Door <sup>(6,7)</sup>	3	8' x 10'	•	•	•	•	•
	1 1/2	8' x 10'	•	•	•	•	•
Stainless Steel Door (Type 304 or 316)	3	3'4 x 8'	•	•	•	•	•
	1 1/2	4' x 8' 8' x 8' 8' x 8' 8' x 8'	• • • •	• • • •	• • • •	• • • •	• • • •
Dutch Door	3	4' x 8'	•	•	•	•	•
Louvered Door <sup>(7)</sup>	1 1/2	4' x 10'	•	•	•	•	•
		8' x 10'	•	•	•	•	•
Sound Control Door (STC 52 Maximum)	3	4' x 8'	•	•	•	•	•
		8' x 8'	•	•	•	•	•
Detention Security Door <sup>(6)</sup>	3	4' x 8'	•	•	•	•	•
		8' x 8'	•	•	•	•	•
Bullet-Resistant Door	3	4' x 10'	•	•	•	•	•
		8' x 10'	•	•	•	•	•
Radiation Shielding Door	3	4' x 8'	•	•	•	•	•
		8' x 8'	•	•	•	•	•
		8' x 8'	•	•	•	•	•

(1) : Plus all lower ratings

(2) : 1/2" latch throw for singles to 8'0" height, 3/4" for singles over 8'0" height and all pairs

(3) : Requires mullion behind doors

(4) : Requires mullion between doors

(5) : Requires co-ordinator and carry bar

(6) : Tested to Negative Pressure (UL10b and ANSI/NFPA 252) and Positive Pressure (ANSI/UL10c, UBC 7-2 1997 and ISO 3008)

(7) : Includes hot rolled, cold rolled, galvanized, galvalume and Type 430 stainless steel

## SUMMARY - FIRE DOOR FRAME PRODUCT

Frame Description	Maximum Rating (Hours) <sup>(1)</sup>	Swinging Singly Swinging in Pairs	Maximum Door Opening	Maximum Individual Transom Panel Size	Thickness	Material	Anchors	Maximum Over-All Unit Size
					0.093" (2.3 mm, 12 ga) 0.067" (1.7 mm, 14 ga) 0.053" (1.3 mm, 16 ga)	Mild Steel <sup>(2)</sup> Type 430 Stainless Steel Type 304/316 Stainless Steel	Masonry Concrete Wood/Steel Stud	
Three-Sided Frame <sup>(5)</sup>	3	• •	4' x 10' 8' x 10'	-	• • •	• • •	• • •	
Double Egress <sup>(5)</sup>	3	•	8' x 10'	-	• • •	• • •	• • •	
Multi-Opening Frames or Transom Frames <sup>(5)</sup>	1½	• •	4' x 10' 8' x 10'	8' x 4'	• • •	• • •	• • •	12'8" x 8'0" Frames 12'8" x 10' Transom Frames
Transom Frame with 1¾" Panel No Transom Mullion <sup>(5)</sup>	3	• •	4' x 9' 8' x 9'	4' x 4'6" 8' x 4'	• • •	• • •	• • •	11'10" <sup>(3)</sup> Height 11'2" <sup>(3)</sup> Height
Transom Frame with 1¾" Panel and Transom Mullion <sup>(5)</sup>	3	• •	4' x 10' 8' x 10'	4' x 4' 8' x 4'	• • •	• • •	• • •	11'10" <sup>(3)</sup> Height
Transom Frame with Panel and Transom Mullion <sup>(5)</sup>	3	• •	4' x 10' 8' x 10'	4' x 4' 8' x 4'	• • •	• • •	• • •	12" <sup>(3)</sup> Height
Transom Frame Glazed <sup>(5)</sup>	1½ <sup>(4)</sup>	• •	4' x 10' 8' x 10'	- -	• • •	• • •	• • • • • •	12" <sup>(3)</sup> Height 11'4" <sup>(3)</sup> Height 12" <sup>(3)</sup> Height 11'4" <sup>(3)</sup> Height
Sidelight Frame Glazed or Paneled <sup>(5)</sup>	1½ <sup>(4)</sup>	• •	4' x 10' 8' x 10'	8' x 4'	• • •	• •	• • • • • •	13'6" x 12' 12'10" x 11'4" 13'6" x 12' 12'10" x 11'4"
Window Frame Glazed or Paneled <sup>(5)</sup>	1½ <sup>(4)</sup>	- -	-	-	• • •	• •	• • • • • •	13'6" x 12' 12'10" x 11'4"
Sound Control Frame (STC 52 Maximum)	3	• •	4' x 8' 8' x 8'	-	• • •	• •	• • •	
Detention Security Frame <sup>(5)</sup>	3	• •	4' x 8' 8' x 8'	-	• •	• •	• •	
Bullet-Resistant Frame	3	• •	4' x 10' 8' x 10'	-	• • •	• •	• • •	
Radiation Shielding Frame	3	• •	4' x 8' 8' x 8'	-	• • •	• •	• • •	

(1) : Plus all lower ratings

(2) : Includes hot rolled, cold rolled, galvanized and galvalneal steel

(3) : Combined door and transom panel height

(4) : With listed laminated or solid ceramic glazing materials. Refer to Section 1, Table 5, Page 1-10 for other available glazing materials and their ratings

(5) : Tested to Negative Pressure (UL10b and ANSI/NFPA 252) and Positive Pressure (ANSI/UL10c, UBC 7-2 1997 and ISO 3008)





# NOTES

---

# NOTES

---